



Nobleza y Tradición

Nobleza y
Tradición



PUERTAS RÚSTICAS
Alpujarreñas



SERIE I
Puertas Rústicas

Características Puertas Rústicas SERIE I · Features of SERIES I doors · Caractéristiques des portes SÉRIE I



PUERTAS RÚSTICAS
Alpujarreñas

- Fabricadas con madera de pino silvestre de Suecia de primera calidad.
- Marco directo 95 x 95 mm moldurado y tallado.
- Cerradura de seguridad de tres puntos.
- Tratamiento especial a poro abierto para exterior y acabado nogal a la cera.
- Burlete de goma embutida en el perfil del marco.
- Herrajes de forja artesanales según modelo.
- Cortavientos automático marca HSS.

- Premium wood doors made from Swedish Wild Pine.
- Moulded and carved frame 95 x 95 mm.
- Three point security lock.
- Open pore treatment for exterior and waxed walnut finish.
- Weatherstrip (Seals drafts from around the top and sides of the door).
- Handmade ironworks.
- Automatic door bottom seal (HSS brand).

- Portes en bois de grande qualité fabriquées en pin sauvage de Suède.
- Cadre moulé et sculpté de 95 x 95 mm.
- Serrure de sécurité trois points.
- Traitement spécial à pores ouvertes pour extérieur, finition noyer ciré.
- Cadre de porte avec joint d'isolation en caoutchouc.
- Éléments métalliques forgés à la main.
- Coupe-vent automatique de la marque HSS.



Cristal laminado

Ventana abatible

Burlete de goma

Cerradura de seguridad

Cortavientos

· Todas las puertas se fabrican con marcado CE

SECCIÓN PUERTAS SERIE I DOORS SECTION SERIES I · SECTION PORTES SÉRIE I

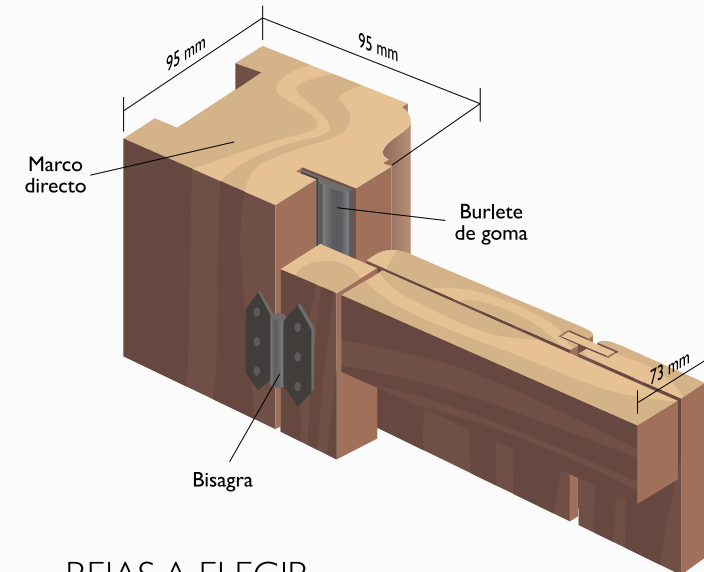

REJAS A ELEGIR

WROUGHT IRON GRILLS OPTIONS

GRILLES EN FER FORGÉ À CHOISIR (compris dans le tarif)



Ref. 1

Ref. 2

Ref. 3

Ref. 4

Ref. 5

Ref. 6



Hoja: 92,5 x 210 cm

Mod.A-II (170 x 250)



Vista frontal Mod. A-II (170 x 250)

Model A-II front view (170 x 250)

Vue face du modèle A-II (170 x 250)

SERIE I Exterior

Comares

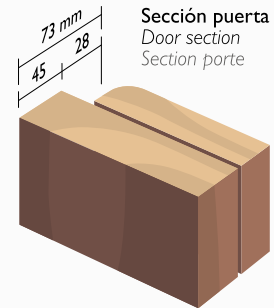

Sección puerta
Door section
Section porte

Tabla de 28 mm. Grueso total de la hoja: 73 mm
Panel thickness: 28 mm. Total door thickness: 73 mm
Épaisseur du panneau: 28 mm. Épaisseur totale de la porte: 73 mm



Mod.A-12 con 2 Fijos (162 x 211)
Mod.A-13 con 2 Fijos (172 x 218)



Mod.A-12 con 1 Fijo (131 x 211)



Mod.A-13 con 1 Fijo (141 x 218)



Hoja: 82 x 203 cm Mod. A-12 (99 x 211)
Hoja: 92 x 210 cm Mod. A-13 (109 x 218)



2 Hojas: 64 x 215 cm

Mod.A-14 (144 x 224)

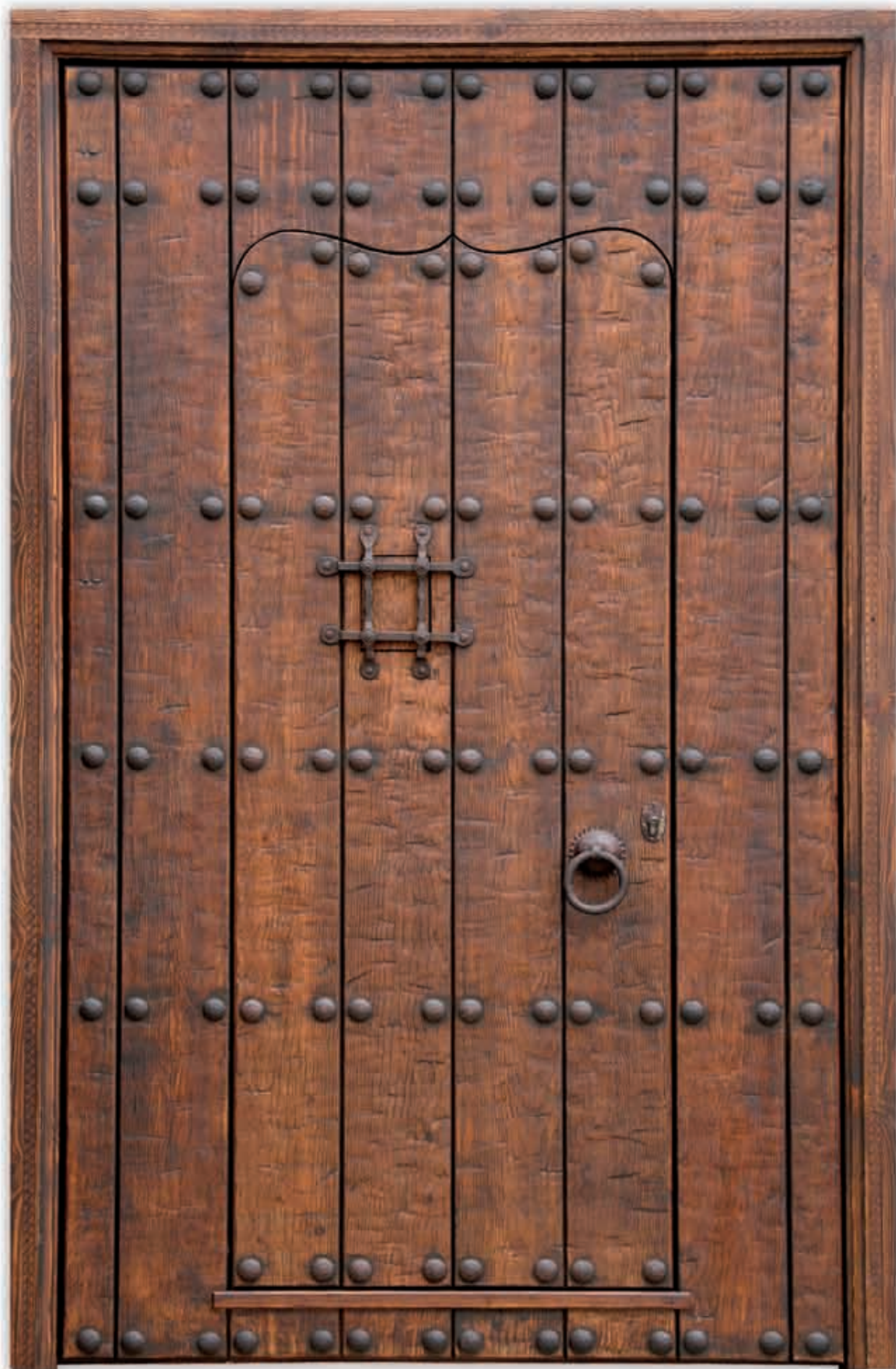

Hoja ext: 139 x 232 / Hoja int: 82,5 x 192

Mod. B-1 (155 x 240)



Vista frontal Mod. B-1 (155 x 240)
 Model B-1 front view (155 x 240)
 Vue face du modèle B-1 (155 x 240)

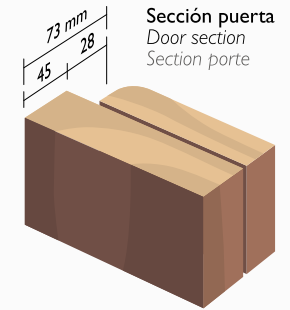

Sección puerta
 Door section
 Section porte

Tabla de 28 mm. Grueso total de la hoja: 73 mm
 Panel thickness: 28 mm. Total door thickness: 73 mm
 Épaisseur du panneau: 28 mm. Épaisseur totale de la porte: 73 mm



Vista trasera Mod. B-3 (99 x 211)
 Model B-3 back view (99 x 211)
 Vue arrière du modèle B-3 (99 x 211)



Hoja: 82,5 x 203

Mod. B-3 (99 x 211)



SERIE I Exterior
Aljimecer

SERIE I



Hoja: 82,5 x 203
 Hoja: 92,5 x 210

Mod. B-2 (99 x 211)
 Mod. B-4 (109 x 218)



2 Hojas de 64 x 215

Mod. B-5 (144 x 224)



Mod. B-2 con 2 Fijos (162 x 211)
 Mod. B-4 con 2 Fijos (172 x 218)



Mod. B-2 con 1 Fijo (131 x 211)



Mod. B-4 con 1 Fijo (141 x 218)



Hoja ext: 139 x 232 / Hoja int: 82,5 x 192

Mod. C-II (155 x 240)



Vista frontal C-II (155 x 240)
Model C-II front view (155 x 240)
Vue face du modèle C-II (155 x 240)



Vista trasera Mod. C-II (155 x 240)
Model C-II back view (155 x 240)
Vue arrière du modèle C-II (155 x 240)



Tabla de 28 mm. Grueso total de la hoja: 73 mm
Panel thickness: 28 mm. Total door thickness: 73 mm
Épaisseur du panneau: 28 mm. Épaisseur totale de la porte: 73 mm

SERIE I Exterior

Aljibe

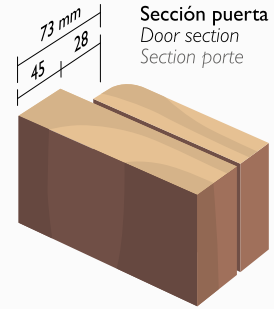

Mod. C-12 con 2 Fijos (162 x 211)
Mod. C-13 con 2 Fijos (172 x 218)



Hoja: 82,5 x 203
Hoja: 92,5 x 210
Mod. C-12 (99 x 211)
Mod. C-13 (109 x 218)



2 Hojas de 64 x 215
Mod. C-14 (144 x 224)



Mod. C-12 con 1 Fijo (131 x 211)



Mod. C-13 con 1 Fijo (141 x 218)

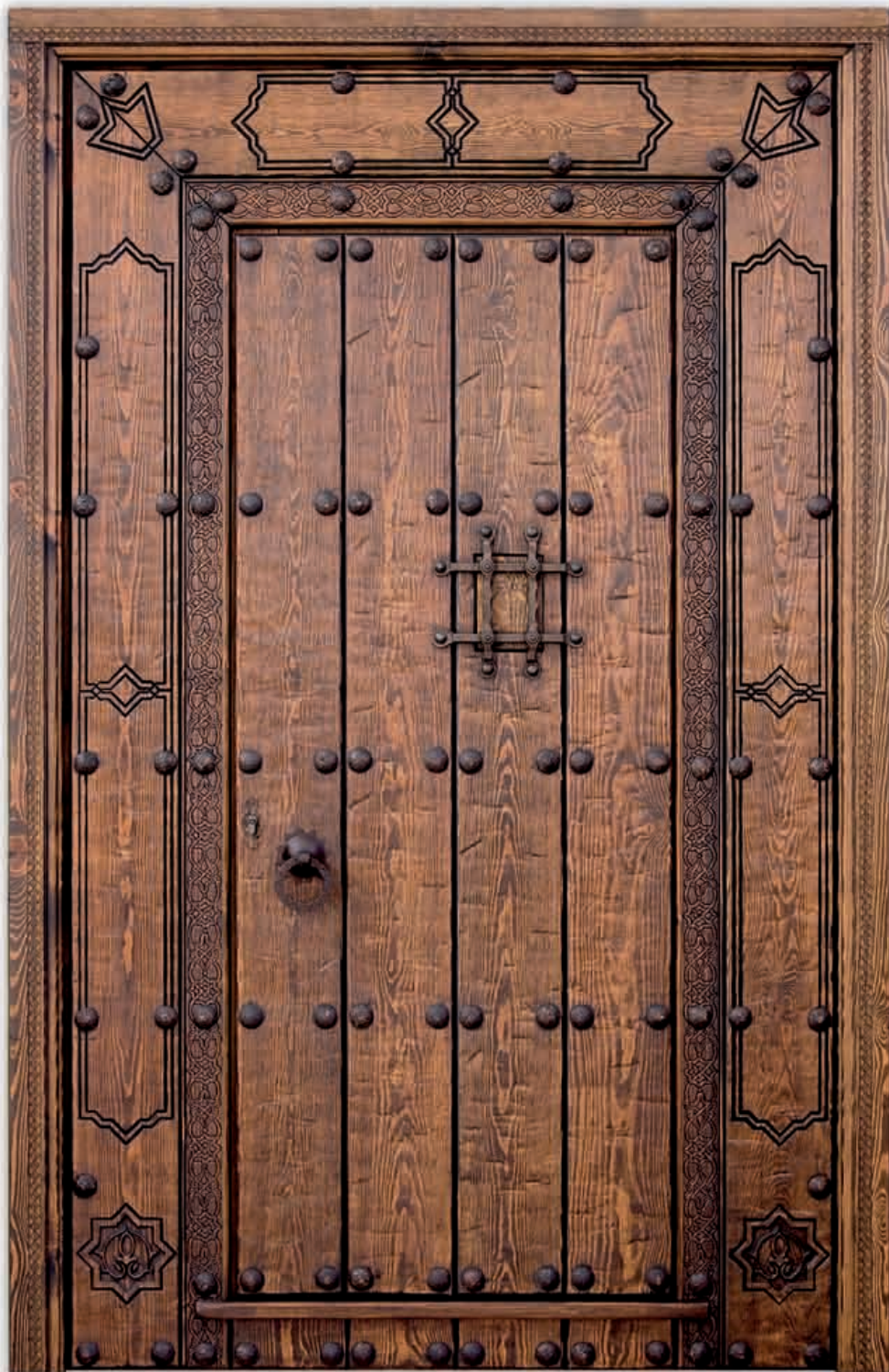

Hoja ext: 139 x 232 / Hoja int: 82,5 x 192

Mod. D-II (155 x 240)



Vista frontal D-II (155 x 240)
Model D-II front view (155 x 240)
Vue face du modèle D-II (155 x 240)



Vista trasera Mod. D-II (155 x 240)
View of back Mod. D-II (155 x 240)
Vista trasera Mod. D-II (155 x 240)

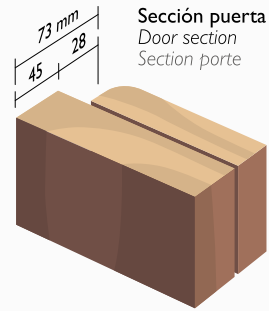

Sección puerta
Door section
Section porte

Tabla de 28 mm. Grueso total de la hoja: 73 mm
Panel thickness: 28 mm. Total door thickness: 73 mm
Épaisseur du panneau: 28 mm. Épaisseur totale de la porte: 73 mm

SERIE I Exterior

Abencerrajes

SERIE I



Mod. D-12 con 2 Fijos (162 x 211)
Mod. D-13 con 2 Fijos (172 x 218)



Hoja: 82,5 x 203
Hoja: 92,5 x 210
Mod. D-12 (99 x 211)
Mod. D-13 (109 x 218)



2 Hojas de 64 x 215
Mod. D-14 (144 x 223)



Mod. D-12 con 1 Fijo (131 x 211)



Mod. D-13 con 1 Fijo (141 x 218)



2 Hojas de 64 x 215



Mod. EI- (144 x 224)

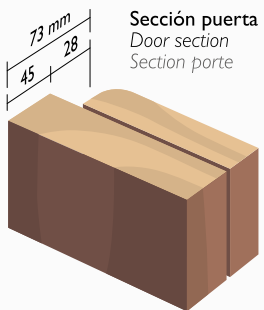

Sección puerta
Door section
Section porte

Tabla de 28 mm. Grueso total de la hoja: 73 mm
Panel thickness: 28 mm. Total door thickness: 73 mm
Épaisseur du panneau: 28 mm. Épaisseur totale de la porte: 73 mm

SERIE I Exterior Nazari



Hoja: 82,5 x 203

Mod. E-2 (99 x 211)



Hoja: 92,5 x 210

Mod. E-3 (109 x 218)



Mod. E-2 con 2 Fijos (162 x 211)
Mod. E-3 con 2 Fijos (172 x 218)



Mod. E-2 con 1 Fijo (131 x 211)



Mod. E-3 con 1 Fijo (141 x 218)

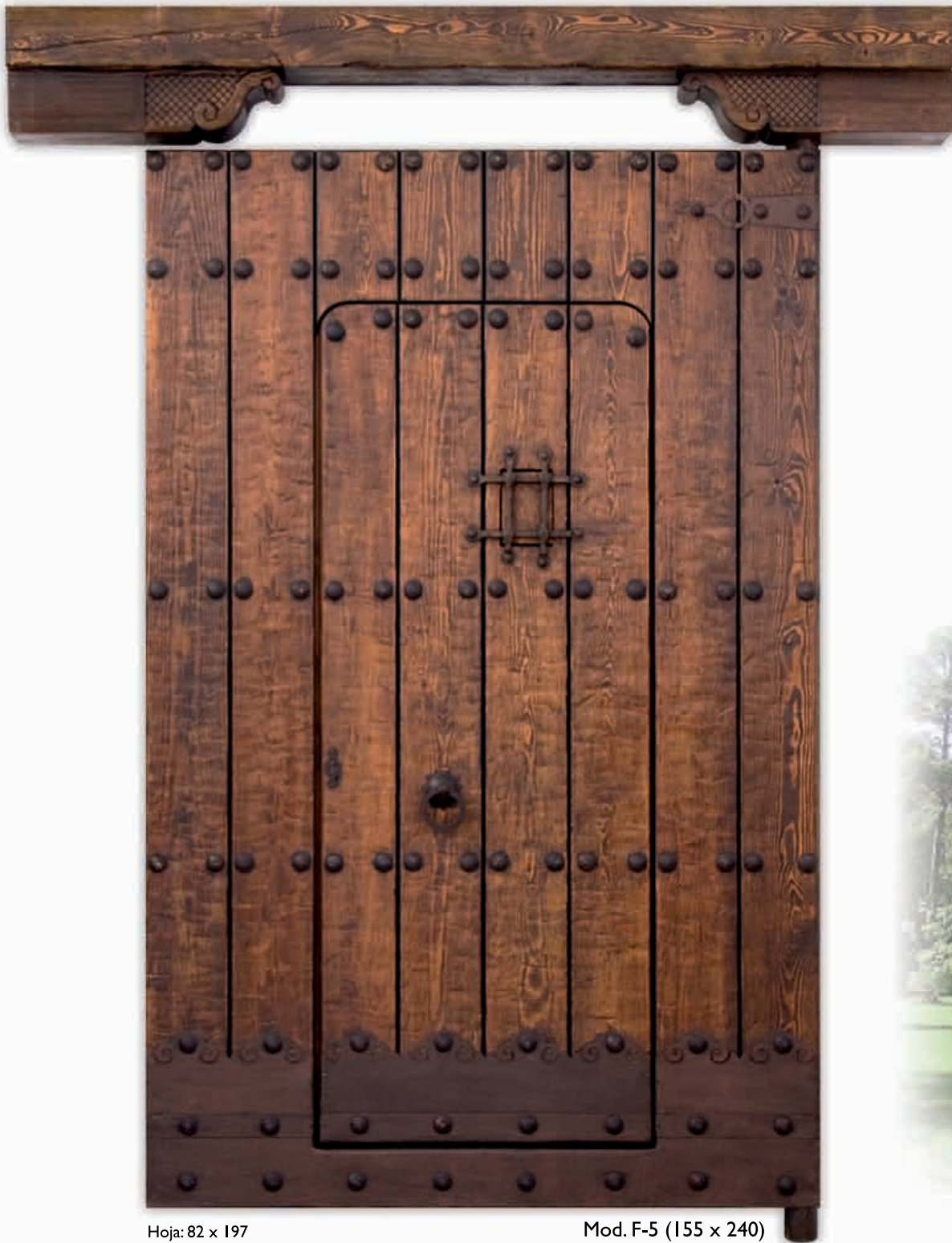

Hoja: 82 x 197

Mod. F-5 (155 x 240)



Vista puertas F5 (155 x 240)

View of door Mod. F5 (155 x 240)

Vista puertas Mod. F5 (155 x 240)



Tabla de 28 mm. Grueso total de la hoja: 73 mm
Panel thickness: 28 mm. Total door thickness: 73 mm
Épaisseur du panneau: 28 mm. Épaisseur totale de la porte: 73 mm

SERIE I Exterior

Alcazaba

SERIE I

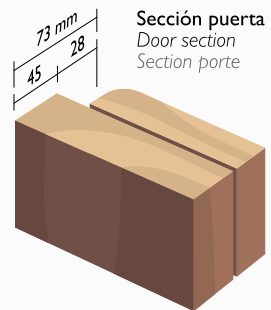

Hoja: 82,5 x 203
Hoja: 92,5 x 210
Mod. F-2 (99 x 211)
Mod. F-3 (109 x 218)



2 Hojas de 64 x 215
Mod. F-1 (144 x 223)



Mod. F-2 con 2 Fijos (162 x 211)
Mod. F-3 con 2 Fijos (172 x 218)



Mod. F-3 con 1 Fijo (141 x 218)



Mod. F-2 con 1 Fijo (131 x 211)



Hoja: 92,5 x 210

Mod. G-1 (109 x 218)



Hoja: 82,5 x 203
Hoja: 92,5 x 210

Mod. G-30 (99 x 211)
Mod. G-31 (109 x 218)



Hoja: 82,5 x 203
Hoja: 92,5 x 210

Mod. G-20 (99 x 211)
Mod. G-21 (109 x 218)





Tabla de 28 mm. Grueso total de la hoja: 73 mm
Panel thickness: 28 mm. Total door thickness: 73 mm
Épaisseur du panneau: 28 mm. Épaisseur totale de la porte: 73 mm

SERIE I Exterior Albaicín



Mod. G-1 con 2 Fijos (172 x 218)

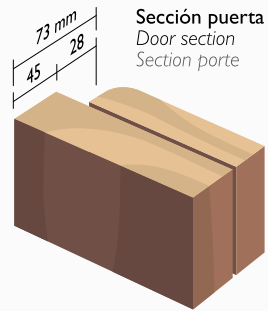

Mod. G-20 con 2 Fijos (162 x 211)
Mod. G-21 con 2 Fijos (172 x 218)



Mod. G-30 con 2 Fijos (162 x 211)
Mod. G-31 con 2 Fijos (172 x 218)



Mod. G-1 con 1 Fijo (141 x 218)



Mod. G-20 con 1 Fijo (131 x 211)
Mod. G-21 con 1 Fijo (141 x 218)



Mod. G-30 con 1 Fijo (131 x 211)
Mod. G-31 con 1 Fijo (141 x 218)

SERIE I Exterior
Tahona



Hoja: 82,5 x 203
 Hoja: 92,5 x 210

Mod. I-11 (99 x 211)
Mod. I-12 (109 x 218)



Vista trasera Mod. I-12 (109 x 218)
View of back Mod. I-12 (109 x 218)
Vista trasera Mod. I-12 (109 x 218)



Mod. I-11 con 2 Fijos (162 x 211)
Mod. I-12 con 2 Fijos (172 x 218)



Mod. I-11 con 1 Fijo (131 x 211)



Mod. I-12 con 1 Fijo (141 x 218)

SERIE I Exterior Lindaraja



Tabla de 45 mm. Grueso total de la hoja: 55 mm
Panel thickness: 45 mm. Total door thickness: 55 mm
Épaisseur du panneau: 45 mm. Épaisseur totale de la porte: 55 mm



2 Hojas de 59 x 228

Mod. H-3 (134 x 236)

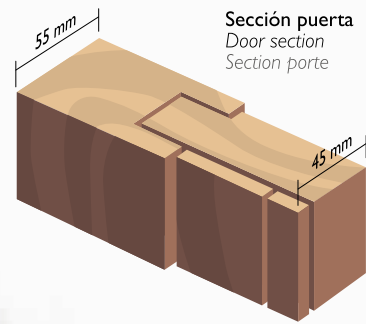

2 Hojas de 66,5 x 232



Mod. J-I (149 x 240)



Tabla de 28 mm. Grueso total de la hoja: 73 mm
Panel thickness: 28 mm. Total door thickness: 73 mm
Épaisseur du panneau: 28 mm. Épaisseur totale de la porte: 73 mm

SERIE I Exterior

Sultana

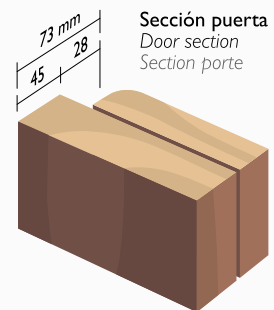

Hoja: 82,5 x 215

Mod. J-2 (99 x 223)



Hoja: 92,5 x 215

Mod. J-3 (109 x 223)



Mod. J-2 con 2 Fijos (162 x 223)
Mod. J-3 con 2 Fijos (172 x 223)



Mod. J-2 con 1 Fijo (131 x 223)



Mod. J-3 con 1 Fijo (141 x 223)



2 Hojas: de 68 x 215

Mod. HA-1 (152 x 224)



Hoja: 82 x 203
Hoja: 92 x 210

Mod. HA-2 (99 x 211)
Mod. HA-3 (109 x 218)



Vista trasera Mod. HA-2 (99 x 211)
 Model HA-2 back view (99 x 211)
 Vue arrière du modèle HA-2 (99 x 211)

SERIE I Exterior Dalia



Tabla de 28 mm. Grueso total de la hoja: 55 mm
 Panel thickness: 28 mm. Total door thickness: 55 mm
 Épaisseur du panneau: 28 mm. Épaisseur totale de la porte: 55 mm



Mod. HA-2 + 1 Fijo (131 x 211)

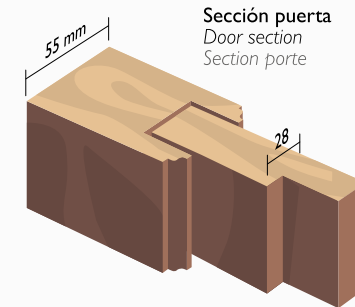

Mod. HA-3 + 1 Fijo (141 x 218)



Mod. HA-2 + 2 Fijos (162 x 211)
 Mod. HA-3 + 2 Fijos (172 x 218)



2 Hojas de 68 x 215

Mod. XA-1 (152 x 224)



Hoja: 82 x 203
Hoja: 92 x 210

Mod. XA-2 (99 x 211)
Mod. XA-3 (109 x 218)



SERIE I Exterior

Azahar



Tabla de 28 mm. Grueso total de la hoja: 55 mm
 Panel thickness: 28 mm. Total door thickness: 55 mm
 Épaisseur du panneau: 28 mm. Épaisseur totale de la porte: 55 mm



Mod. XA-2 + 1 Fijo (131 x 211)

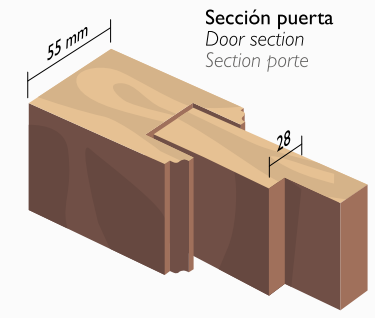

Mod. XA-3 + 1 Fijo (141 x 218)



Mod. XA-2 + 2 Fijos (162 x 211)
 Mod. XA-3 + 2 Fijos (172 x 218)



2 Hojas: 68 x 215

Mod. NB-10 (144 x 224)



Hoja: 82 x 205
Hoja: 92 x 210
Hoja: 102 x 215

Mod. NB-11 (99 x 211)
Mod. NB-12 (109 x 218)
Mod. NB-13 (119 x 223)

SERIE I Exterior Alcázar



Vista trasera NB-10 (144 x 224)
Model NB-10 back view (144 x 224)
Vue arrière du modèle NB-10 (144 x 224)

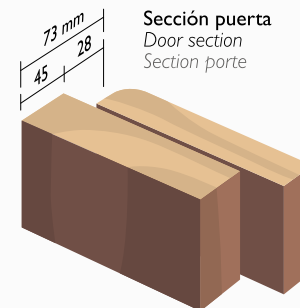

Sección puerta
Door section
Section porte

Tabla de 28 mm. Grueso total de la hoja: 73 mm
Panel thickness: 28 mm. Total door thickness: 73 mm
Épaisseur du panneau: 28 mm. Épaisseur totale de la porte: 73 mm



Mod. NB-11 + 1 Fijo (131 x 211)



Mod. NB-12 + 1 Fijo (141 x 218)



Mod. NB-11 + 2 Fijos (162 x 211)
Mod. NB-12 + 2 Fijos (172 x 218)

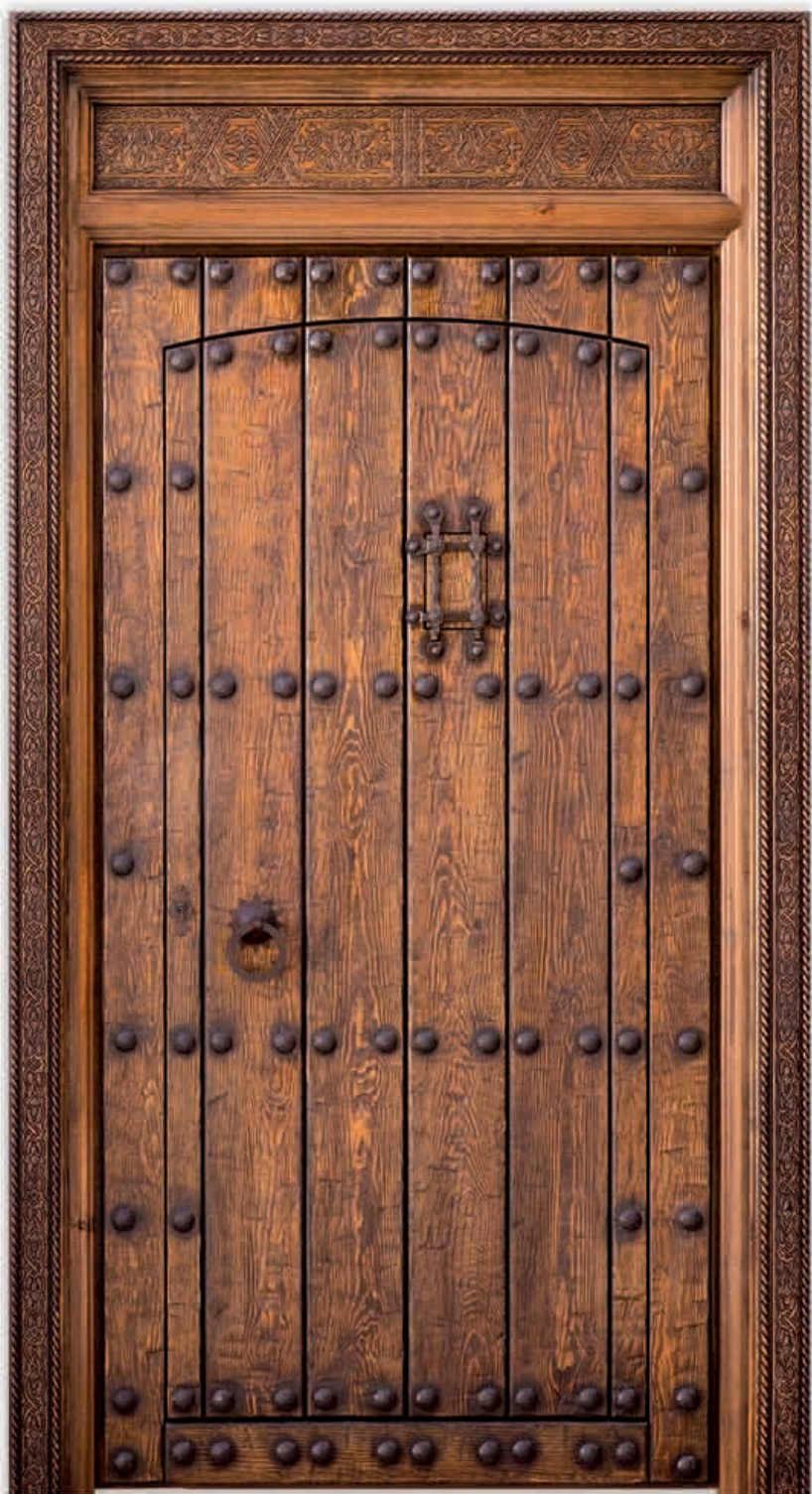

Hoja grande: 113 x 220
Hoja paso: 92 x 200

Mod. ZA-1 (141 x 258)



Hoja: 92 x 210

Mod. ZA-2 (120 x 225)



Detalle Mod. ZA-2



Detalle Mod. ZA-2



Detalle Mod. ZA-3



Hoja: 82,5 x 203

Mod. ZA-3 (99 x 211)



Hoja: 82 x 203
Hoja: 92 x 210

Mod. G-25 (99 x 211)
Mod. G-26 (109 x 218)

SERIE I Exterior

Alcudiar



Tabla de 28 mm. Grueso total de la hoja: 73 mm
Panel thickness: 28 mm. Total door thickness: 73 mm
Épaisseur du panneau: 28 mm. Épaisseur totale de la porte: 73 mm



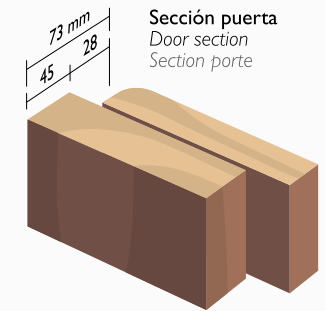

2 Hojas de 68 x 215

Mod. G-60 (144 x 223)



Hoja: 82 x 203
Hoja: 92 x 210

Mod. G-61 (99 x 211)
Mod. G-62 (109 x 218)

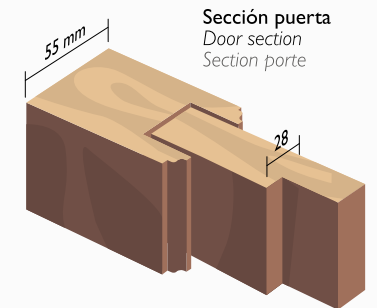

Sección puerta
Door section
Section porte

Tabla de 28 mm. Grueso total de la hoja: 55 mm
Panel thickness: 28 mm. Total door thickness: 55 mm
Épaisseur du panneau: 28 mm. Épaisseur totale de la porte: 55 mm



Vista trasera Mod. G-61 (99 x 211)
Model G-61 back view (99 x 211)
Vue arrière du modèle G-61 (99 x 211)

SERIE I Exterior
Colmenar



Arco AR-1



Arco AR-2



Arco AR-3



Mod. G-61 + 1 Fijo (131 x 211)



Mod. G-62 + 1 Fijo (141 x 218)



Mod. G-61 + 2 Fijos (162 x 211)
 Mod. G-62 + 2 Fijos (172 x 218)



2 Hojas de 68 x 215

Mod. NK-11 (152 x 222)



Hoja: 82 x 203
Hoja: 92 x 210

Mod. NK-12 (99 x 211)
Mod. NK-13 (109 x 218)

SERIE I Exterior

Gálvez



Tabla de 28 mm. Grueso total de la hoja: 55 mm
 Panel thickness: 28 mm. Total door thickness: 55 mm
 Épaisseur du panneau: 28 mm. Épaisseur totale de la porte: 55 mm



Mod. NK-12 + 1 Fijo (131 x 211)

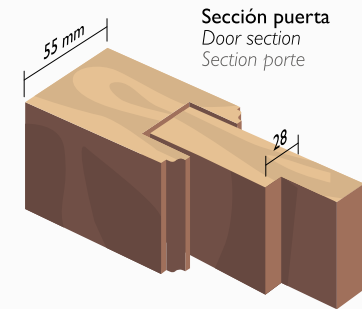

Mod. NK-13 + 1 Fijo (141 x 218)



Mod. NK-12 + 2 Fijos (162 x 211)
 Mod. NK-13 + 2 Fijos (172 x 218)

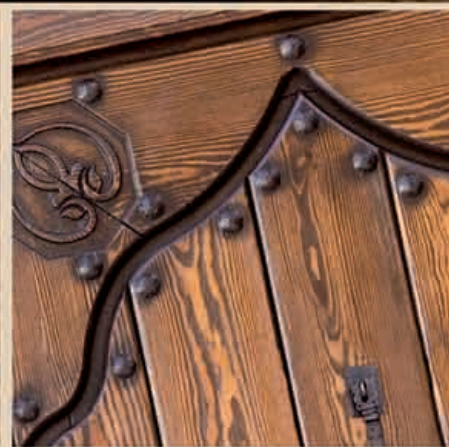

SERIE II
Puertas Rústicas



Características Puertas Rústicas SERIE II · Features of SERIES II doors · Caractéristiques des portes SÉRIE II



PUERTAS RÚSTICAS
Alpujarreñas

- Puertas exteriores fabricadas con madera de pino rojo.
- Marco directo moldurado 70 x 95 mm (grosor por ancho).
- Grosor de hoja (armazón + tablas) de 68 mm.
- Herrajes y pernios entrelazados.
- Cerradura de seguridad de tres puntos.
- Llamador y tiradores rústicos envejecidos.
- Tratamiento especial a poro abierto para exterior y acabado nogal a la cera.

- Exterior doors made from red pine wood.
- Moulded frame 70 x 95 mm (thick x width).
- Total door thickness: 68mm (frame + panel).
- High quality hinges.
- Three point security lock.
- Aged rustic doorknob and knocker.
- Open pore treatment for exterior and waxed walnut finish.

- Portes en bois pour extérieur fabriquées en pin rouge.
- Cadre moulé de 70 x 95 mm (épaisseur X largeur).
- Épaisseur de porte totale: 68mm (cadre + panneaux).
- Charnières de grande qualité.
- Serrure de sécurité trois points.
- Pommeau et heurtoirs rustiques vieillis.
- Traitement spécial à pores ouvertes pour extérieur, finition noyer ciré.



Cerradura de seguridad

SECCIÓN PUERTAS SERIE II DOORS SECTION SERIES II · SECTION PORTES SÉRIE II

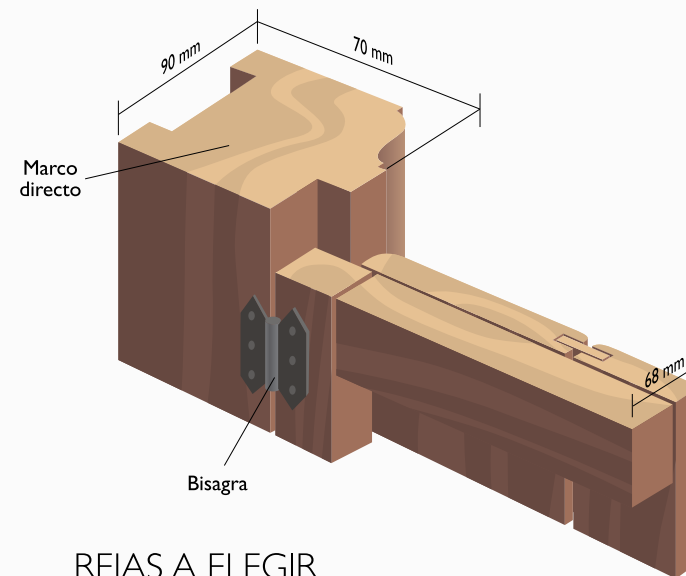

REJAS A ELEGIR WROUGHT IRON GRILLS OPTIONS GRILLES EN FER FORGÉ À CHOISIR

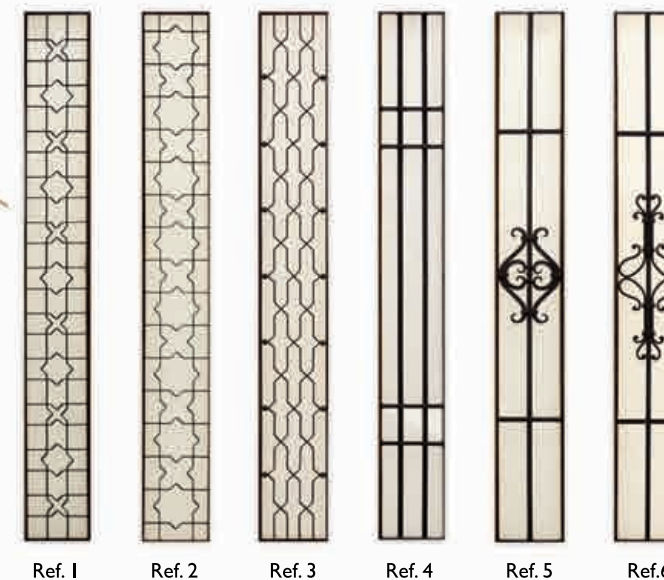

· Todas las puertas se fabrican con marcado CE

Sección puerta
Door section
Section porte



Tabla de 23 mm. Grueso total de la hoja: 68 mm
Panel thickness: 23 mm. Total door thickness: 68 mm
Épaisseur du panneau: 23 mm. Épaisseur totale de la porte: 68 mm

SERIE II Exterior Daxara

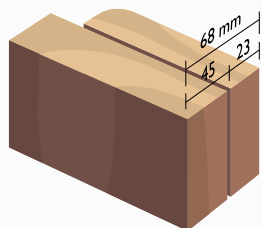

2 Hojas de 64 x 215

Mod. U-1 (139 x 221)



Hoja: 82,5 x 203
Hoja: 92,5 x 210

Mod. U-2 (94 x 209)
Mod. U-3 (104 x 216)



Mod. U-2 con 2 Fijos (152 x 209)
Mod. U-3 con 2 Fijos (162 x 216)



Mod. U-2 con 1 Fijo (123 x 209)



Mod. U-3 con 1 Fijo (133 x 216)

Sección puerta
Door section
Section porte



Tabla de 23 mm. Grueso total de la hoja: 68 mm
Panel thickness: 23 mm. Total door thickness: 68 mm
Épaisseur du panneau: 23 mm. Épaisseur totale de la porte: 68 mm

SERIE II Exterior Bermeja

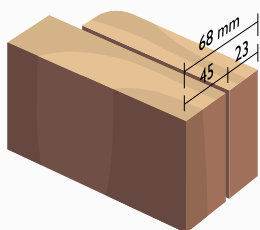
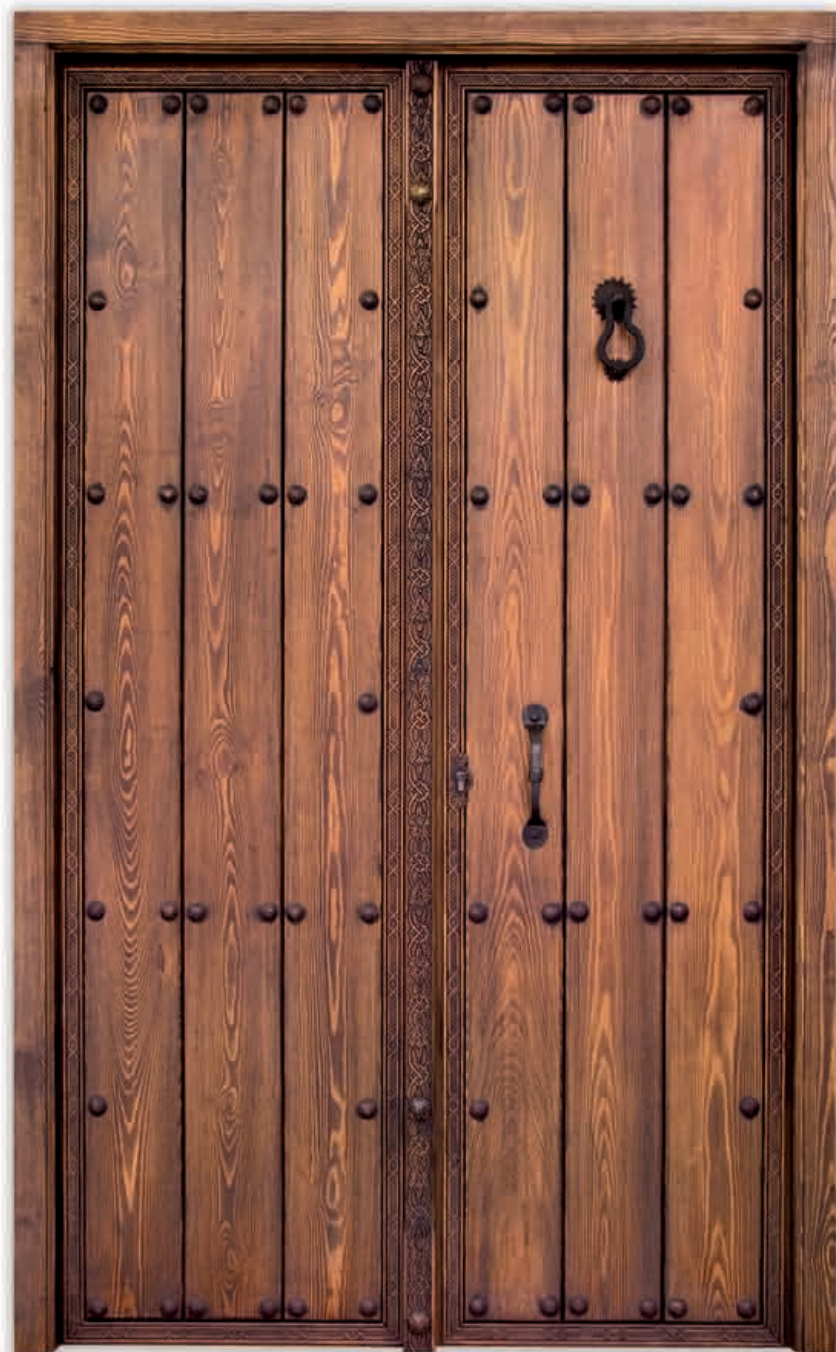

2 Hojas de 64 x 215

Mod. P-1 (139 x 221)



Hoja: 82,5 x 203
Hoja: 92,5 x 210

Mod. P-2 (94 x 209)
Mod. P-3 (104 x 216)



Mod. P-2 con 2 Fijos (152 x 209)
Mod. P-3 con 2 Fijos (162 x 216)



Mod. P-2 con 1 Fijo (123 x 209)



Mod. P-2 con 1 Fijo (133 x 216)

Sección puerta
Door section
Section porte



Tabla de 28 mm. Grueso total de la hoja: 73 mm
Panel thickness: 28 mm. Total door thickness: 73 mm
Épaisseur du panneau: 28 mm. Épaisseur totale de la porte: 73 mm

SERIE II Exterior Generalife

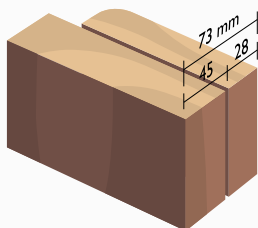

2 Hojas de 64 x 215

Mod. Q-1 (139 x 221)

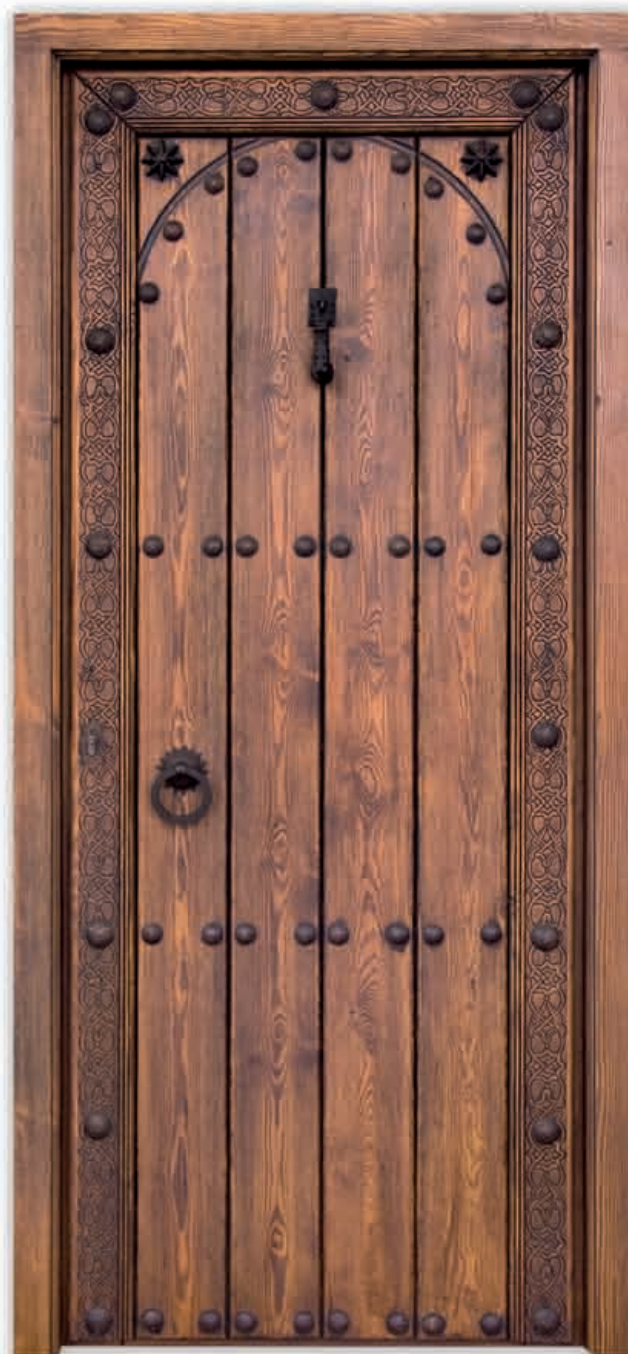

Hoja: 82,5 x 203
Hoja: 92,5 x 210

Mod. Q-2 (94 x 209)
Mod. Q-3 (104 x 216)



Mod. Q-2 con 2 Fijos (152 x 209)
Mod. Q-3 con 2 Fijos (162 x 216)



Mod. Q-2 con 1 Fijo (123 x 209)



Mod. Q-3 con 1 Fijo (133 x 216)

Sección puerta
Door section
Section porte



Tabla de 23 mm. Grueso total de la hoja: 68 mm
Panel thickness: 23 mm. Total door thickness: 68 mm
Épaisseur du panneau: 23 mm. Épaisseur totale de la porte: 68 mm

SERIE II Exterior Califa

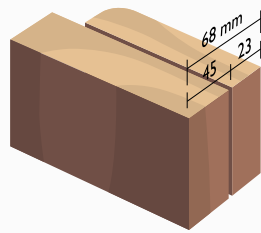

2 Hojas de 64 x 215

Mod. R-1 (139 x 221)



Hoja: 82,5 x 203
Hoja: 92,5 x 210

Mod. R-2 (94 x 209)
Mod. R-3 (104 x 216)



Mod. R-2 con 2 Fijos (152 x 209)
Mod. R-3 con 2 Fijos (162 x 216)



Mod. R-2 con 1 Fijo (123 x 209)



Mod. R-3 con 1 Fijo (133 x 216)

Sección puerta
Door section
Section porte



Tabla de 23 mm. Grueso total de la hoja: 68 mm
Panel thickness: 23 mm. Total door thickness: 68 mm
Épaisseur du panneau: 23 mm. Épaisseur totale de la porte: 68 mm

SERIE II Exterior Adelfa

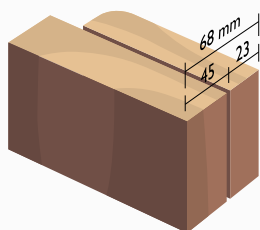

2 Hojas de 64 x 215

Mod. S-1 (139 x 221)

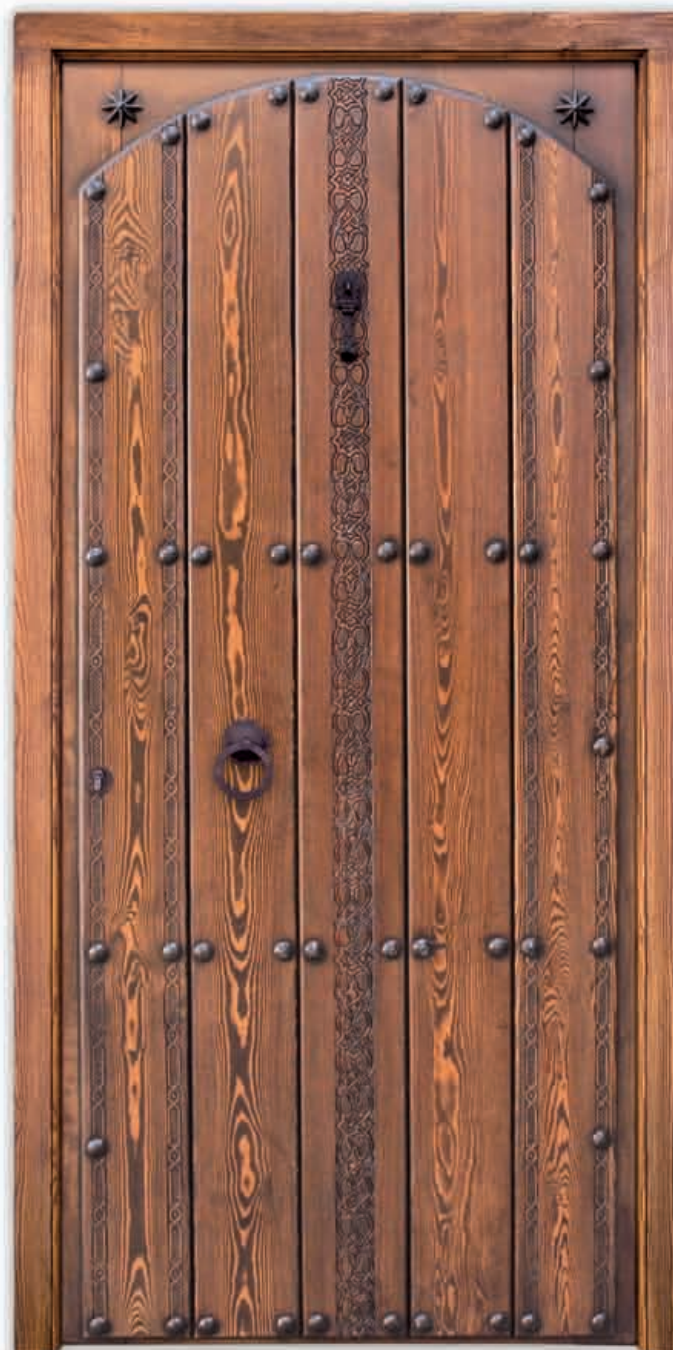

Hoja: 82,5 x 203
Hoja: 92,5 x 210

Mod. S-2 (94 x 209)
Mod. S-3 (104 x 216)



Mod. S-2 con 2 Fijos (152 x 209)
Mod. S-3 con 2 Fijos (162 x 216)



Mod. S-2 con 1 Fijo (123 x 209)



Mod. S-3 con 1 Fijo (133 x 216)

Sección puerta
Door section
Section porte



Tabla de 23 mm. Grueso total de la hoja: 68 mm
Panel thickness: 23 mm. Total door thickness: 68 mm
Épaisseur du panneau: 23 mm. Épaisseur totale de la porte: 68 mm

SERIE II Exterior Taifas

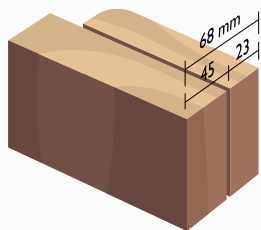

2 Hojas de 64 x 215

Mod. N-1 (139 x 221)



Hoja: 82,5 x 203
Hoja: 92,5 x 210

Mod. N-2 (94 x 209)
Mod. N-3 (104 x 216)



Mod. N-2 con 2 Fijos (152 x 209)
Mod. N-3 con 2 Fijos (162 x 216)



Mod. N-2 con 1 Fijo (123 x 209)



Mod. N-3 con 1 Fijo (133 x 216)

Sección puerta
Door section
Section porte



Tabla de 23 mm. Grueso total de la hoja: 68 mm
Panel thickness: 23 mm. Total door thickness: 68 mm
Épaisseur du panneau: 23 mm. Épaisseur totale de la porte: 68 mm

SERIE II Exterior Rauda

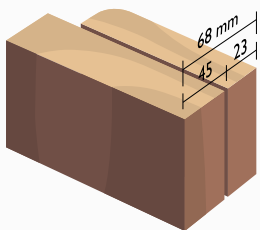

2 Hojas de 64 x 215

Mod. T-1 (139 x 221)



Hoja: 82,5 x 203
Hoja: 92,5 x 210

Mod. T-2 (94 x 209)
Mod. T-3 (104 x 216)



Mod. T-2 con 2 Fijos (152 x 209)
Mod. T-3 con 2 Fijos (162 x 216)



Mod. T-2 con 1 Fijo (123 x 209)



Mod. T-3 con 1 Fijo (133 x 216)

Sección puerta
Door section
Section porte



Tabla de 23 mm. Grueso total de la hoja: 68 mm
Panel thickness: 23 mm. Total door thickness: 68 mm
Épaisseur du panneau: 23 mm. Épaisseur totale de la porte: 68 mm

SERIE II Exterior Andalusí

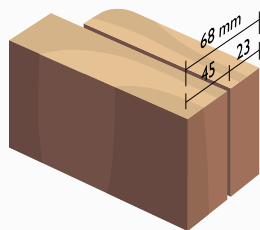

Hoja: 82,5 x 203
Hoja: 92,5 x 210

Mod. AN-1 (94 x 209)
Mod. AN-2 (104 x 216)



Hoja: 82,5 x 203
Hoja: 92,5 x 210

Mod. P-24 (94 x 209)
Mod. P-25 (104 x 216)



Mod. P-24 con 2 Fijos (152 x 209)
Mod. P-25 con 2 Fijos (162 x 216)



Mod. P-24 con 1 Fijo (123 x 209)



Mod. P-25 con 1 Fijo (133 x 216)



Mod. AN-1 con 2 Fijos (152 x 209)
Mod. AN-2 con 2 Fijos (162 x 216)



Mod. AN-1 con 1 Fijo (123 x 209)



Mod. AN-2 con 1 Fijo (133 x 216)



SERIE INTERIOR
Puertas Rústicas

Características Puertas Rústicas SERIE INTERIOR

Features of SERIES INTERIOR doors

Caractéristiques des portes SÉRIE INTÉRIEUR

- Puertas elaboradas en madera de pino rojo montadas en block.
- Incluyen bisagras, mecanizado del block más pernios y picaporte de petaca.
- Galce de 30 mm fabricado a medida del cliente.
- Tapajuntas tallados de 90 mm a dos caras.
- Barniz para interiores con acabado nogal a la cera.
- No incluyen cristales ni manivelas.

- Bloc-porte en pin rouge.
- Charnières et réservation de poignée incluses.
- Épaisseur de cadre: 30mm, fabriqué sur mesure.
- Chambranle sculpté en 90 mm (des deux côtés).
- Vernis pour intérieur finition noyer ciré.
- Poignées et verre en option.

- Pre-hung door made from red pine wood.
- Hinges and drilling the door for a handle are included.
- Frame thickness: 30mm. It's made to client measurement.
- Carved door casing 90 mm (external and internal side).
- Varnish for interior and waxed walnut finish.
- Handle and glass not included.

SECCIÓN PUERTAS DE INTERIOR INTERIOR DOORS SECTION · SECTION PORTES INTÉRIEURES

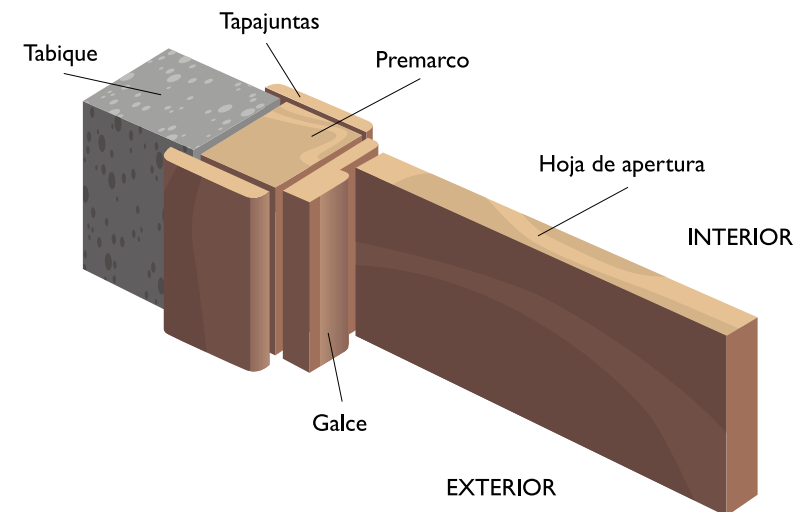

ELEMENTOS OPCIONALES

OPTIONAL ACCESSORIES · ACCESSOIRES EN OPTION

Manivelas · Handles · Poignée



Manivela negra
Black handle
Poignée noire

Manivela bronce
envejecido satinado
Aged bronze handle
Poignée en bronze satiné et vieilli

APERTURA DE PUERTA HANDING · OUVERTURE

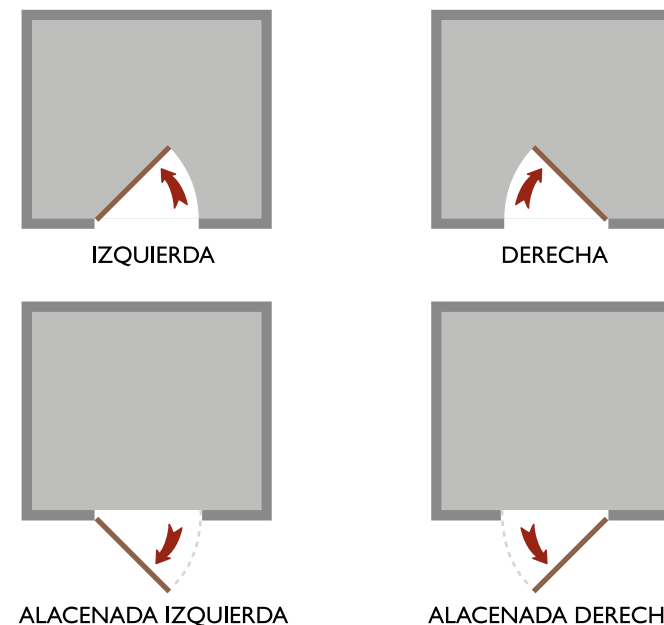

Sección puerta
Door section
Section porte



Tabla de 22 mm. Grueso total de la hoja: 45 mm
Panel thickness: 22 mm. Total door thickness: 45 mm
Épaisseur du panneau: 22 mm. Épaisseur totale de la porte: 45 mm

SERIE Interior Medina

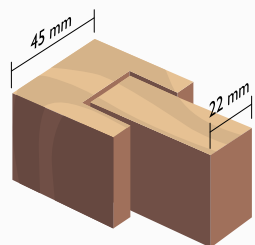

Hoja: 62,5 x 203
Hoja: 72,5 x 203
Hoja: 82,5 x 203

Mod.Ab-1 (66 x 205)
Mod.Ab-2 (76 x 205)
Mod.Ab-3 (86 x 205)



Hoja: 62,5 x 203
Hoja: 72,5 x 203
Hoja: 82,5 x 203

Mod.Ab-4 (66 x 205)
Mod.Ab-5 (76 x 205)
Mod.Ab-6 (86 x 205)



Sección puerta
Door section
Section porte



Tabla de 22 mm. Grueso total de la hoja: 45 mm
Panel thickness: 22 mm. Total door thickness: 45 mm
Épaisseur du panneau: 22 mm. Épaisseur totale de la porte: 45 mm

SERIE Interior Alarife

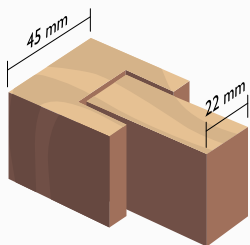

Hoja: 62,5 x 203
Hoja: 72,5 x 203
Hoja: 82,5 x 203

Mod. X-1 (66 x 205)
Mod. X-2 (76 x 205)
Mod. X-3 (86 x 205)



Hoja: 62,5 x 203
Hoja: 72,5 x 203
Hoja: 82,5 x 203

Mod. X-4 (66 x 205)
Mod. X-5 (76 x 205)
Mod. X-6 (86 x 205)



Sección puerta
Door section
Section porte



Tabla de 22 mm. Grueso total de la hoja: 35 mm
Panel thickness: 22 mm. Total door thickness: 35 mm
Épaisseur du panneau: 22 mm. Épaisseur totale de la porte: 35 mm



Sección puerta ambas caras talladas. OPCIONAL
Section of both carved sides. OPTIONAL.
Section de porte sculptée des deux côtés en OPTION.

SERIE Interior Dama

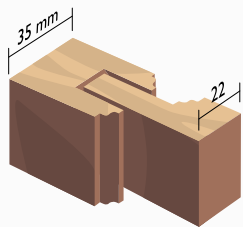
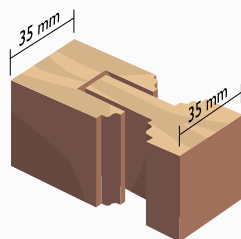

Hoja: 62,5 x 203
Hoja: 72,5 x 203
Hoja: 82,5 x 203

Mod.V-1 (66 x 205)
Mod.V-2 (76 x 205)
Mod.V-3 (86 x 205)



Hoja: 62,5 x 203
Hoja: 72,5 x 203
Hoja: 82,5 x 203

Mod.V-4 (66 x 205)
Mod.V-5 (76 x 205)
Mod.V-6 (86 x 205)



Sección puerta
Door section
Section porte



Tabla de 28 mm. Grueso total de la hoja: 45 mm
Panel thickness: 28 mm. Total door thickness: 45 mm
Épaisseur du panneau: 28 mm. Épaisseur totale de la porte: 45 mm

SERIE Interior Adarves K

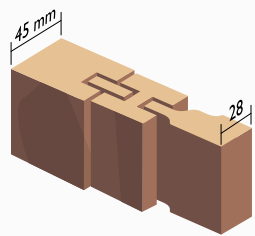
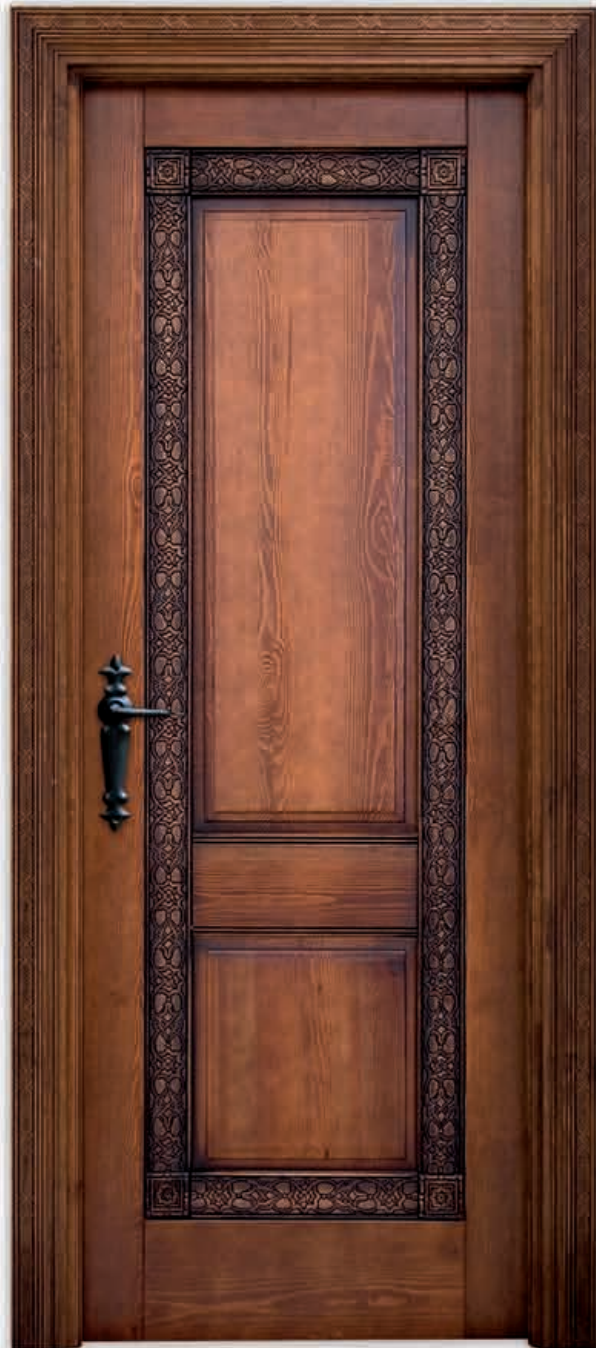

Hoja: 62,5 x 203
Hoja: 72,5 x 203
Hoja: 82,5 x 203

Mod. K-11 (66 x 205)
Mod. K-12 (76 x 205)
Mod. K-13 (86 x 205)



Hoja: 62,5 x 203
Hoja: 72,5 x 203
Hoja: 82,5 x 203

Mod. K-14 (66 x 205)
Mod. K-15 (76 x 205)
Mod. K-16 (86 x 205)



Sección puerta
Door section
Section porte



Tabla de 28 mm. Grueso total de la hoja: 45 mm
Panel thickness: 28 mm. Total door thickness: 45 mm
Épaisseur du panneau: 28 mm. Épaisseur totale de la porte: 45 mm



Sección puerta ambas caras talladas. OPCIONAL
Section of both carved sides. OPTIONAL.
Section de porte sculptée des deux côtés en OPTION.

SERIE Interior Adarves L

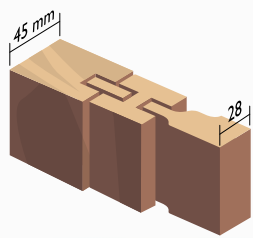
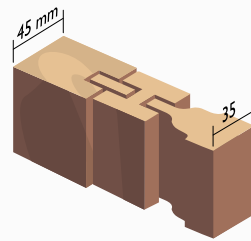

Hoja: 62,5 x 203
Hoja: 72,5 x 203
Hoja: 82,5 x 203

Mod. L-11 (66 x 205)
Mod. L-12 (76 x 205)
Mod. L-13 (86 x 205)



Hoja: 62,5 x 203
Hoja: 72,5 x 203
Hoja: 82,5 x 203

Mod. L-14 (66 x 205)
Mod. L-15 (76 x 205)
Mod. L-16 (86 x 205)



Sección puerta
Door section
Section porte



Tabla de 28 mm. Grueso total de la hoja: 45 mm
Panel thickness: 28 mm. Total door thickness: 45 mm
Épaisseur du panneau: 28 mm. Épaisseur totale de la porte: 45 mm

SERIE Interior Tahona

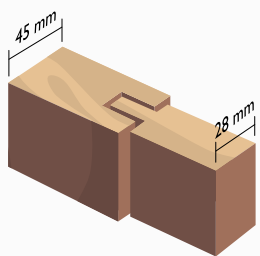
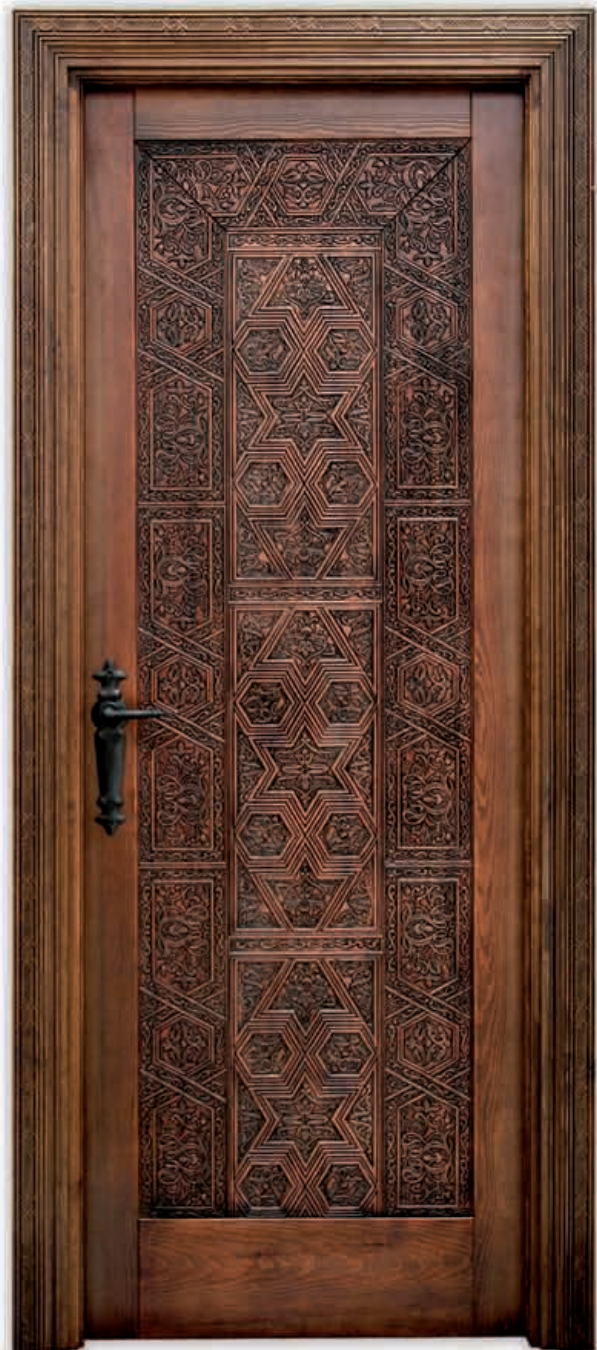

Hoja: 62,5 x 203
Hoja: 72,5 x 203
Hoja: 82,5 x 203

Mod. M-11 (66 x 205)
Mod. M-12 (76 x 205)
Mod. M-13 (86 x 205)



Hoja: 62,5 x 203
Hoja: 72,5 x 203
Hoja: 82,5 x 203

Mod. M-14 (66 x 205)
Mod. M-15 (76 x 205)
Mod. M-16 (86 x 205)



Sección puerta
Door section
Section porte



Tabla de 23 mm. Grueso total de la hoja: 35 mm
Panel thickness: 23 mm. Total door thickness: 35 mm
Épaisseur du panneau: 23 mm. Épaisseur totale de la porte: 35 mm



Sección puerta ambas caras talladas. OPCIONAL
Section of both carved sides. OPTIONAL.
Section de porte sculptée des deux côtés en OPTION.

SERIE Interior Casablanca

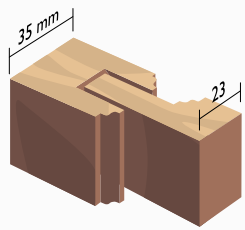
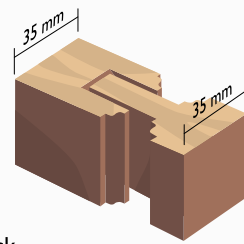
Con arco en block



Hoja: 62,5 x 203
Hoja: 72,5 x 203
Hoja: 82,5 x 203

Mod. YA-1 (66 x 205)
Mod. YA-2 (76 x 205)
Mod. YA-3 (86 x 205)

Con arco en block



Hoja: 62,5 x 203
Hoja: 72,5 x 203
Hoja: 82,5 x 203

Mod. YA-4 (66 x 205)
Mod. YA-5 (76 x 205)
Mod. YA-6 (86 x 205)



Sección puerta
Door section
Section porte



Tabla de 23 mm. Grueso total de la hoja: 35 mm
Panel thickness: 23 mm. Total door thickness: 35 mm
Épaisseur du panneau: 23 mm. Épaisseur totale de la porte: 35 mm



Sección puerta ambas caras talladas. OPCIONAL
Section of both carved sides. OPTIONAL.
Section de porte sculptée des deux côtés en OPTION.

SERIE Interior Casablanca

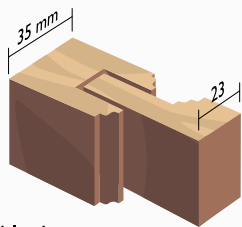
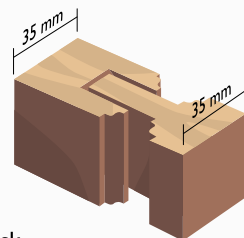
Sin arco en block



Hoja: 62,5 x 203
Hoja: 72,5 x 203
Hoja: 82,5 x 203

Mod.YA-7 (66 x 205)
Mod.YA-8 (76 x 205)
Mod.YA-9 (86 x 205)

Sin arco en block



Hoja: 62,5 x 203
Hoja: 72,5 x 203
Hoja: 82,5 x 203

Mod.YA-10 (66 x 205)
Mod.YA-11 (76 x 205)
Mod.YA-12 (86 x 205)



Puertas por encargo

Customized door · Portes fabriquées sur mesure



Hoja: 102,5 x 205

Mod. F-50 (133 x 263)

Sección puerta
Door section
Section porte



Tabla de 28 mm. Grueso total de la hoja: 83 mm
Panel thickness: 28 mm. Total door thickness: 83 mm
Épaisseur du panneau: 28 mm. Épaisseur totale de la porte: 83 mm



Mod. G-50 (145 x 280)

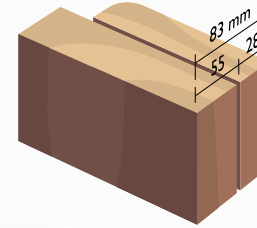

Detalle Mod. G-50



Detalle Mod. F-50

Frentes de armario a medida

Customized closet door · Portes de placard sur mesure



EMBOCADURAS

ARCHITRAVES · CHAMBRANLE AVEC BAGUETTE DÉCORATIVE

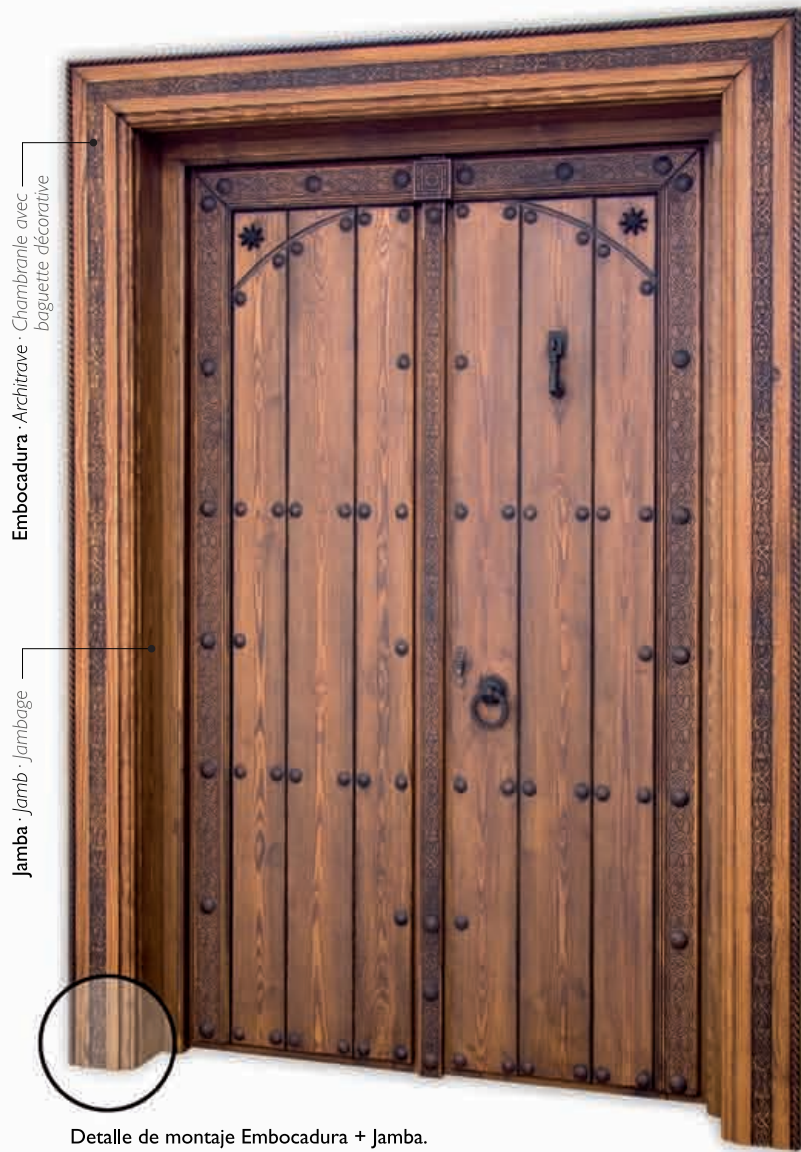

Embocadura · Architrave · Chambranle avec baguette décorative

Jamba · Jamb · Jambage



Detalle de montaje a inglete.
Detail of miter joint.
Détail de montage sur l'onglet.

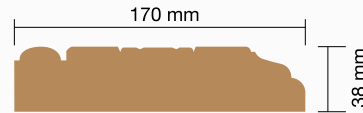

Embocadura EBI - 170 mm
Architrave EBI - 170 mm
Chambranle avec baguette décorative EBI - 170 mm

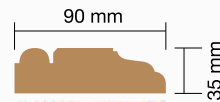

Embocadura EB2 - 90 mm
Architrave EB2 - 90 mm
Chambranle avec baguette décorative EB2 - 90 mm

Detalle de montaje Embocadura + Jamba.
Detail of assembly (Architrave + Jamb).
Détail d'assemblage du chambranle avec baguette décorative + jambage.

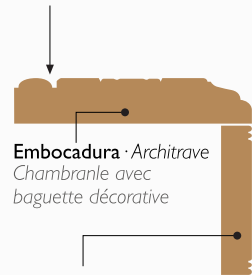

Embocadura · Architrave
Chambranle avec baguette décorative

Jamba (X mm) según obra
Jamb made to the wall measure
Jambage (X mm) fournis selon les mesures de la paroi

Características Jambas

· Se fabrican a medida de la obra.

Características Embocaduras

· Se sirven en tiras para todos los modelos de puertas y marcos con fijos.
· La medida se hace proporcional a la puerta (según indicaciones del cliente).

Jamb's features

· Made to the wall measure.

Architraves features

· Provided in pieces. Available for all door models.
· Made to the door measure (According to clients specifications).

Caractéristiques Jambage

· Fournis selon les mesures de la paroi.

Caractéristiques chambranle avec baguette décorative

· Fournis en sections pour tous les modèles de portes et d'encadrements.
· A la mesure de la porte (selon les indications du client).

Accesorios opcionales para puertas de exterior

Optional accessories for exterior doors

Accessoires en option pour les portes extérieures

TAPAJUNTAS · CASING · CHAMBRANLE

Se sirven por caras según la medida de la puerta.

It provides two sides and one top with the door specifications.

Fournis selon les mesures de la porte.



RTT taco tallado 95 mm.
RTT Carved corner block 95 mm.
RTT bloc d'angle sculpté 95 mm.



RT1 - 90mm



RT2 - 70mm



Detalle montaje taco.
Detail of assembled corner block.
Détail d'assemblage du bloc d'angle.



RT3 - 90mm



RT4 - 90mm

CORTAVIENTOS AUTOMATIC DOOR BOTTOM SEAL COUPE-VENT AUTOMATIQUE



Opción cortavientos sólo para SERIE II
Option: automatic door bottom seal (SERIES II)
Option: Coupe-vent automatique (SÉRIE II)

KIT DE MANTENIMIENTO MAINTENANCE KIT KIT D'ENTRETIEN



Compuesto por:
· Taco lija de espuma
· Guantes de látex
· Brocha
· Cinta
· Gamuza de algodón
· Impregnante
· Jabón neutro

Composed of:
· Foam sanding block
· Latex gloves
· Paint brush
· Masking tape
· Chamois cloth
· Impregnant
· Mild soap

Composition:
· Cale-éponge à poncer en mousse
· Gants en latex
· Brosse
· Ruban de masquage
· Peau de chamois
· Lasure d'imprégnation
· Savon doux



Artesonados y Zócalos

Coffered Ceilings and Baseboards · Lambris plafonds et murs en bois massif





PUERTAS RÚSTICAS
Alpujarreñas

Para más información consulte nuestro catálogo.

For more information, see our catalogue.

Pour plus d'informations, n'hésitez pas à consulter notre catalogue.





diseño: targetcreativo.net



PUERTAS RÚSTICAS
Alpujarreñas

Carpintería Alpujarreña, S.L.
Ctra. Trevélez-Granada, Km 1
Haza de la Cuna, s/n.
18417 TREVÉLEZ (Granada)
Telf.: 958 85 87 04
Fax: 958 85 86 67
www.puertastrusticas.com
correo@puertastrusticas.com

Todas las referencias expuestas en este catálogo así como los dibujos están patentadas por Carpintería Alpujarreña, S.L. Queda prohibida la copia, plagio o imitación de las mismas sin expresa autorización por escrito del propietario de la patente, amparada por la ley 20/2003 de Diseños Industriales y en su Reglamento de ejecución.

All references and drawings in this catalogue are patented by Carpintería Alpujarreña S.L. It is forbidden without prior written authorization from Carpintería Alpujarreña S.L. to copy, plagiarize and imitate either wholly or in part, any component of this catalogue. It's protected by Industrial Designs Law (20/2003) and its Executive Regulation.

Tous les produits et dessins présentés dans ce catalogue sont brevetés par Carpintería Alpujarreña, S.L. Il est strictement interdit, sans l'autorisation préalable par écrit de Carpintería Alpujarreña, S.L., de copier ou imiter tout élément de ce catalogue. Son contenu est protégé par la Loi sur les Dessins Industriels 20/2003 et par son Règlement Exécutif.

