

CATÁLOGO GENERAL

2017

PLACAS

TECHOS

AISLAMIENTO

CALORIFUGADOS

COMPLEMENTOS

PRECIOS
ACTUALIZADOS
01/01/2018

- PLACO
- ULTIPRO
- PROMAT

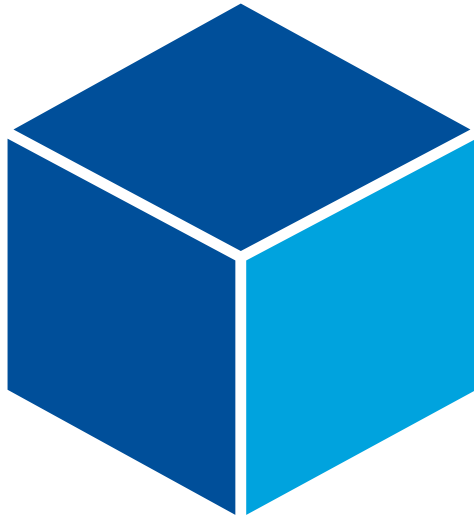

PLACAS



Placas técnicas para interiores

Placa	Resistencia humedad	Resistencia bacterias	Resistencia impacto	Resistencia al fuego	Aislamiento térmico	Aislamiento acústico	Techos	Carga	Fabricante
GLASROC X	★★★★	★★★★		★			★★	★	PLACO
AQUAROC	★★★★		★★	★	★	★	★★	★	PLACO
GLASROC F			★★	★★★★	★	★	★★	★	PLACO
PPH			★	★★	★	★★★★	★★	★	PLACO
PIP			★★★★	★★	★	★	★★	★	PLACO
PHD			★★★★		★	★	★★	★	PLACO
RIGIDUR	★		★★★★	★	★	★★★★	★★	★★	PLACO
HABITO			★★★★	★★	★	★★★★	★★	★★★★	PLACO
4PRO			★	★		★★	★★★★	★	PLACO
4PRO PPM	★★★★	★★★★	★	★		★★	★★★★	★	PLACO
FERMACELL	★★		★★	★★	★	★★	★★	★	FERMACELL
FIREPANEL	★★		★★	★★★★	★	★★	★★	★	FERMACELL
POWER PANEL	★★★★		★★	★★	★	★★	★★	★	FERMACELL
HYDROPANEL	★★★★	★★	★★★★	★★			★★	★★	PROMAT
DURIPANEL	★★★★		★★				★★	★★	EURONIT

Placa de yeso laminado 4PRO y 4PRO PPM13

4PRO y 4PRO PPM13 de PLACO son unas placas exclusivas que, al tener sus cuatro bordes afinados, proporciona una alta calidad en el acabado de techos, trasdosados y tabiques.

Las placas de yeso laminado 4PRO y 4PRO PPM13 ahorran tiempo y dinero, ofreciendo una alta calidad de acabado superficial de los paramentos, especialmente en áreas sometidas a la acción de la luz rasante. Las placas 4PRO y 4PRO PPM13 de Placo son perfectas para todo tipo de viviendas de nueva construcción o rehabilitación, centros comerciales, médicos, deportivos y educativos; así como en techos de gran superficie, pasillos y corredores, entre otros.

Los bordes afinados de las nuevas placas 4PRO y 4PRO PPM13 permiten conseguir una superficie final más lisa. Su instalación evita el exceso de espesor en las juntas de los bordes transversales, logrando una calidad de superficie similar a un nivel Q3, que satisface los altos requerimientos de acabado sin necesidad de enlucido posterior de todo el paramento.



Acabado junta Placa BA.

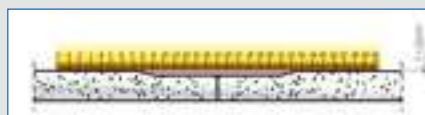

Acabado junta Placa 4Pro.

VENTAJAS

La placa **4PRO** ofrece la máxima resistencia y el menor riesgo de fisuras gracias a sus bordes afinados, que proporcionan un refuerzo en las juntas. El acabado de la junta con la placa 4PRO es más rápido. Diferentes pruebas realizadas han demostrado que el uso de la 4PRO proporciona un **ahorro de tiempo de hasta un 30%** en el proceso de realización y finalización de la junta en comparación con la placa BA.

Además, con la instalación de 4PRO de Placo se consigue **hasta un 60% de ahorro en el consumo de material para el tratamiento de las juntas** de los bordes transversales. El consumo de pasta de juntas en bordes rectos es de 0,25 kg/m de junta, mientras que en los lados cortos de la placa 4PRO es de 0,10 kg/m.

DATOS TÉCNICOS

Nombre	Aspecto bordes	Dimensiones		
		Espesor	Tipo	Longitud
4PRO		12,5 mm	1200 mm	2000 mm
				2500 mm
4PRO PPM13		12.5 mm	1200 mm	2000 mm



Sistemas Placo - Ejecución de juntas

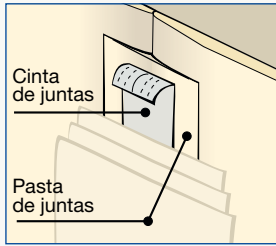

EJECUCIÓN DE JUNTAS

CON UNA CORRECTA **EJECUCIÓN DE JUNTAS**, ASEGURAMOS LA **UNIÓN**, LA **CONTINUIDAD** Y EL **CORRECTO ACABADO** DE LOS PARAMENTOS.

MATERIALES A EMPLEAR

Cinta de juntas

Banda armada

Pasta de juntas, en polvo o preparada

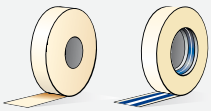

Es importante elegir las herramientas adecuadas



PASOS



1 Aplicar una **mano de pasta** sobre la junta.



2 Colocar la **cinta de papel** centrada entre las juntas de la placa.

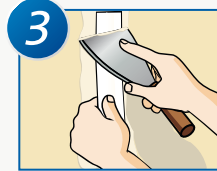

3 Presionar con la **espátula** la **cinta de papel**, retirando el **exceso** de pasta.



4 Aplicar una **segunda mano de pasta** una vez seca la primera.



5 Aplicar una **tercera mano de pasta** una vez seca la segunda.



6 Los **encuentros** con el resto de la obra se realizarán de manera análoga.

INTERSECCIÓN DE JUNTAS

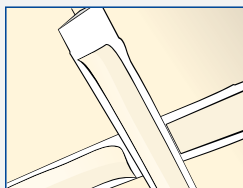

Evitar que las **cintas se solapen** para evitar **regresos**.

REFUERZO DE ÁNGULOS

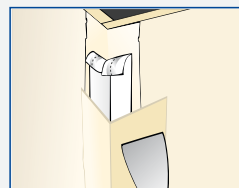

Reforzar las **esquinas** con el empleo de la **Banda armada**.

Más información en: www.placo.es

Placas de yeso laminado

PLACA DE YESO LAMINADO STANDARD

BA 6 mm

Descripción	Fabricante	Código	U.V.	F. P.	PVP €
BA 6x1200x3000	PLACO	00013839	m ²	V13P52	8,05

BA 10 mm

BA 10x1200x2500	PLACO	00013646	m ²	V13P52	5,30
-----------------	-------	----------	----------------	--------	------

BA 13 mm

BA 13x1200x2000	PLACO	00013671	m ²	V13P52	5,25
BA 13x1200x2500	PLACO	00013699	m ²	V13P52	5,25
BA 13x1200x2600	PLACO	00013709	m ²	V13P52	5,25
BA 13x1200x2700	PLACO	00013718	m ²	V13P52	5,25
BA 13x1200x2800	PLACO	00013723	m ²	V13P52	5,25
BA 13x1200x3000	PLACO	00013736	m ²	V13P52	5,25

BA 15 mm

BA 15x1200x2000	PLACO	99204862	m ²	V13P52	6,20
BA 15x1200x2500	PLACO	00013754	m ²	V13P52	6,20
BA 15x1200x2600	PLACO	00013761	m ²	V13P52	6,20
BA 15x1200x2700	PLACO	00013790	m ²	V13P52	6,20
BA 15x1200x2800	PLACO	00013772	m ²	V13P52	6,20
BA 15x1200x3000	PLACO	00013785	m ²	V13P52	6,20



BA 18 mm

BA 18x1200x2500	PLACO	00013811	m ²	V13P52	8,50
-----------------	-------	----------	----------------	--------	------

MEGAPLAC

MEGAPLAC 25x900x2500	PLACO	99320492	m ²	V13P80	11,40
----------------------	-------	----------	----------------	--------	-------

BA 13 mm

BA 13x600x2000	PLACO	99259462	m ²	V13P52	7,31
BA 13x600x2500	PLACO	99131647	m ²	V13P52	7,31

BRICOLAJE (ESPECIAL PARA MANIPULACIÓN/TRANSPORTE EN HABITÁCULOS REDUCIDOS)

BA 13x900x2000	PLACO	99302980	m ²	V13P52	6,53
BA 13x900x2500	PLACO	99311575	m ²	V13P52	6,53



BC 13

BC 13x1200x2000	PLACO	00043838	m ²	V13P52	5,78
BC 13x1200x2400	PLACO	03522897	m ²	V13P52	5,78
BC 13x1200x2500	PLACO	04050003	m ²	V13P52	5,78
BC 13x1200x3000	PLACO	99322034	m ²	V13P52	5,78

Placas de yeso laminado

PLACA HABITO

PLACA HABITO



Descripción	Fabricante	Código	U.V.	F. P.	PVP €
PLACA HABITO 13x1200x2000	PLACO	72253715	m ²	V13P81	10,50
PLACA HABITO 13x1200x2500	PLACO	04792376	m ²	V13P81	10,50
PLACA HABITO 13x1200x2600	PLACO	04420505	m ²	V13P81	10,50
PLACA HABITO 13x1200x3000	PLACO	04713593	m ²	V13P81	10,50
TORNILLO PM HABITO 3,5x35 mm 250 ud/	PLACO	72371921	cj	V13P95	12,86
bol ESQUINERO FLEXIBLE OPTIMUS 30 ml	PLACO	72328260	rl	V13P95	42,29
ESQUINERO FLEXIBLE AQUABEAD 25 ml	PLACO	72328338	rl	V13P95	55,68



PLACA DE YESO LAMINADO PARA TECHOS PERFECTOS



Descripción	Fabricante	Código	U.V.	F. P.	PVP €
4PRO 13x1200x2500	PLACO	00044952	m ²	V13P52	6,81
4PRO 13x1200x2000	PLACO	00958491	m ²	V13P52	6,81
4PRO PPM13 13x1200x2000	PLACO	04217165	m ²	V13P52	10,00



PLACA DE YESO LAMINADO PARA PROTECCION DE SALAS DE RAYOS X



Descripción	Fabricante	Código	U.V.	F. P.	PVP €
PLACA XROC 13x600x1800	PLACO	71580546	m ²	V13P81	37,93
PLACA XROC 13x600x2400	PLACO	71580584	m ²	V13P81	37,93
TORNILLO XROC 25 mm	PLACO	72381047	cj	V13P95	4,59
TORNILLO XROC 35 mm	PLACO	72381054	cj	V13P95	6,21
TORNILLO XROC 45 mm	PLACO	72381061	cj	V13P95	8,87
PASTA JUNTAS PREPARADA PROMIX XROC 20 kg	PLACO	72458181	ud	V13P81	66,93



PLACA DE YESO LAMINADO ESPECIAL ACÚSTICA



Descripción	Fabricante	Código	U.V.	F. P.	PVP €
PLACA PPH 13x1200x2500	PLACO	99241245	m ²	V13P80	8,98
PLACA PPH 13x1200x3000	PLACO	99241252	m ²	V13P80	8,98
PLACA PPH 15x1200x2500	PLACO	99241270	m ²	V13P80	11,06
PLACA PPH 15x1200x3000	PLACO	99241269	m ²	V13P80	11,06





La nueva placa Habito puede con todo

cargas pesadas - golpes - impactos

www.placo.es

La mejor placa
con total seguridad



Placas de yeso laminado

PLACA DE YESO LAMINADO HIDRÓFUGA

Descripción	Fabricante	Código	U.V.	F. P.	PVP €	
	GLASROC X 13x1200x2000	PLACO	72345647	m ²	V13P81	17,97
	GLASROC X 13x1200x2400	PLACO	72180101	m ²	V13P81	17,97
	GLASROC X 13x1200x3000	PLACO	72278446	m ²	V13P81	17,97



AQUAROC 13x1200x900	PLACO	02580698	m ²	V13P81	29,59
AQUAROC 13x1200x2400	PLACO	03822964	m ²	V13P81	29,59
AQUAROC 13x1200x2500	PLACO	99317780	m ²	V13P81	29,59
AQUAROC 13x1200x3000	PLACO	99317795	m ²	V13P81	29,59

TORNILLO THTPF 25 mm 500 UD	PLACO	03427424	cj	V13P95	20,86
TORNILLO THTPF 38 mm 500 UD	PLACO	03427666	cj	V13P95	27,92
AQUAROC PEGAMENTO CARTUCHO -UNIDAD-	PLACO	00931405	ud	V13P95	13,15



PASTA JUNTAS PROMIX HYDRO 11 kg	PLACO	00960715	ud	V13P93	74,98
PASTA JUNTAS PR HYDRO 25 kg	PLACO	02939348	ud	V13P93	36,92

CINTA MALLA PLACOFINISH 90 ml	PLACO	99132822	rl	V13P95	5,81
CINTA FIBRA VIDRIO 50mmx25m	PLACO	72290808	rl	V13P95	2,55

PPM 13x1200x2000	PLACO	00014618	m ²	V13P52	9,32
PPM 13x1200x2500	PLACO	00014623	m ²	V13P52	9,32
PPM 13x1200x2600	PLACO	00014636	m ²	V13P52	9,32
PPM 13x1200x2700	PLACO	99142667	m ²	V13P52	9,32
PPM 13x1200x3000	PLACO	00014647	m ²	V13P52	9,32
PPM 15x1200x2000	PLACO	99141497	m ²	V13P52	10,56
PPM 15x1200x2500	PLACO	00014672	m ²	V13P52	10,56
PPM 15x1200x2600	PLACO	00014685	m ²	V13P52	10,56
PPM 15x1200x2700	PLACO	00014700	m ²	V13P52	10,56
PPM 15x1200x3000	PLACO	99142818	m ²	V13P52	10,56
PPM 18x1200x2500	PLACO	99291389	m ²	V13P52	17,49

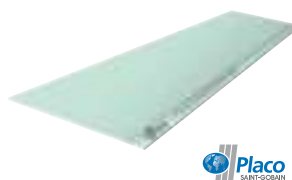

PLACA CON BARRERA DE VAPOR

PLACA PPV

Descripción	Fabricante	Código	U.V.	F. P.	PVP €
PLACA PPV 13x1200x2500	PLACO	00013945	m ²	V13P52	11,79
PLACA PPV 13x1200x3000	PLACO	99142890	m ²	V13P52	11,79

Placas de yeso laminado

PLACA PLACOMUR (PMS)

Descripción	Fabricante	Código	U.V.	F. P.	PVP €
 PLC PLACOMUR PMS 10+20 1200x2600	PLACO	00014182	m ²	V13P80	12,06
PLC PLACOMUR PMS 10+30 1200x2600	PLACO	00014201	m ²	V13P80	13,90
PLC PLACOMUR PMS 10+40 1200x2600	PLACO	00014225	m ²	V13P80	16,37



PLACA ALTA DUREZA Y RESISTENCIA AL IMPACTO

Descripción	Fabricante	Código	U.V.	F. P.	PVP €
 PLACO IMPACT PIP 13x1200x2500	PLACO	2022808	m ²	V13P80	9,62
PLACO IMPACT PIP 13x1200x3000	PLACO	1170214	m ²	V13P80	9,62
PLACO IMPACT PIP 15x1200x2500	PLACO	1535622	m ²	V13P80	11,46
PLACO IMPACT PIP 15x1200x3000	PLACO	1161739	m ²	V13P80	11,46



 PHD 13 1200x3000	PLACO	00013431	m ²	V13P80	8,32
PHD 15 1200x3000	PLACO	00013459	m ²	V13P80	9,44



Descripción	Fabricante	Código	U.V.	F. P.	PVP €
① RIGIDUR H13 BR 1200x2400	PLACO	99314934	m ²	V13P81	18,51
RIGIDUR H13 BC 1200x2400	PLACO	99314916	m ²	V13P81	17,91
② RIGIDUR SOLERA 20x500x1500	PLACO	99314970	m ²	V13P81	33,23
③ RIGIDUR TORNILLO 3,5x30 1000UD	PLACO	00944238	cj	V13P95	24,01
④ RIGIDUR TORNILLO 3,5x40 1000UD	PLACO	02098988	cj	V13P95	34,20
⑤ RIGIDUR PEGAMENTO NATURE LINE SUELO 1Kg	PLACO	99315012	ud	V13P95	17,26
⑥ RIGIDUR PEGAMENTO NATURE LINE JUNTA 310	PLACO	99315027	ud	V13P95	21,27



①



②



③ ④



⑤



⑥

Promat

El cortafuegos más eficiente

La pintura **PROMAPAIN[®]-SC3** permite proteger **estructura metálica** así como **particiones de fábrica de ladrillo o bloque de hormigón** hasta **180 minutos**.

Su composición especial permite conseguir por si misma **acabados finos y atractivos** visualmente, sin necesidad de otras pinturas. Además, siendo a base de agua es **fáciles de aplicar** y respetuosa con el medio ambiente.

Datos Técnicos:

PROMAPAIN[®]-SC3 es una pintura al agua, está exenta de fibras y puede aplicarse tanto para estructuras de tipo "H" e "I" así como para estructuras huecas y en compartimentaciones de ladrillo y hormigón.

Las altas prestaciones de PROMAPAIN[®]-SC3 permiten garantizar una resistencia al fuego hasta R180, con muy bajo espesor.

Promat Ibérica, S.A. Calle Velázquez, 47, 6º Izq. 28001 Madrid Tel.: +34 91 781 15 50 Fax.:+34 91 575 15 97
info@promat.es | www.promat.es



Protección pasiva

PLACA PROTECCIÓN CONTRA EL FUEGO

	Descripción	Fabricante	Código	U.V.	F. P.	PVP €
	PPF 13x1200x2500	PLACO	00014083	m ²	V13P49	8,56
	PPF 13x1200x3000	PLACO	00014098	m ²	V13P49	8,56
	PPF 15x1200x2500	PLACO	00014115	m ²	V13P49	10,57
	PPF 15x1200x3000	PLACO	00014133	m ²	V13P49	10,57



MEGAPLAC PPF

	MEGAPLAC PPF 25x900x2500	PLACO	02251570	m ²	V13P80	21,15
---	---------------------------------	-------	-----------------	----------------	--------	--------------



PLACA GLASROC F

	GLASROC F 25x1200x2500	PLACO	00014502	m ²	V13P81	37,31
--	-------------------------------	--------------	-----------------	----------------	---------------	--------------



HASTA FIN DE EXISTENCIAS

	PANEL TECBOR A 10x1220x2300	TECRESA	99169679	m ²	V13P86	15,68
	PANEL TECBOR A 12x1220x2300	TECRESA	00019602	m ²	V13P86	19,60
	PANEL TECBOR A 15x1220x2300	TECRESA	00019596	m ²	V13P86	21,38
	PANEL TECBOR B 20x1220x2300	TECRESA	00019611	m ²	V13P86	32,07
	PANEL TECBOR B 30x1220x2300	TECRESA	04320368	m ²	V13P86	56,66
	PANEL TECBOR B 40x1220x2300	TECRESA	99169615	m ²	V13P86	71,63
	PANEL TECBOR Y 25x600x1010	TECRESA	03670220	m ²	V13P86	11,14

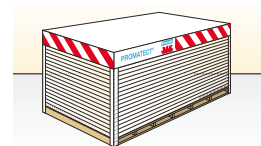

	PROMATECT L-500 20x1200x2500	PROMAT	02808079	m ²	V13P85	48,21
	PROMATECT L-500 25x1200x2500	PROMAT	99148067	m ²	V13P85	60,26
	PROMATECT L-500 30x1200x2500	PROMAT	99148078	m ²	V13P85	72,31
	PROMATECT L-500 35x1200x2500	PROMAT	99148081	m ²	V13P85	84,36
	PROMATECT L-500 40x1200x2500	PROMAT	99148096	m ²	V13P85	96,42
	PROMATECT L-500 50x1200x2500	PROMAT	99148104	m ²	V13P85	120,52
	PROMATECT L-500 52x1200x2500	PROMAT	99148113	m ²	V13P85	125,34
	PROMATECT L-500 60x1200x2500	PROMAT	99148128	m ²	V13P85	144,62



Protección pasiva

PLACA PROTECCIÓN CONTRA EL FUEGO

PLACAS SILICATO CÁLCICO

Descripción	Fabricante	Código	U.V.	F. P.	PVP €
PROMATECT LS 30x1200x2500	PROMAT	99148131	m ²	V13P85	60,93
PROMATECT LS 35x1200x2500	PROMAT	00961101	m ²	V13P85	71,08
PROMATECT LS 45x1200x2500	PROMAT	99148142	m ²	V13P85	91,40
PROMATECT LS 50x1200x2500	PROMAT	72243224	m ²	V13P85	101,55



Promat

PLACA PROMATECT AD 50x1200x2500	PROMAT	71388092	m ²	V13P85	92,25
--	--------	-----------------	----------------	--------	--------------



Promat

PROMATECT 100 10x1200x2500	PROMAT	99147822	m ²	V13P85	20,95
PROMATECT 100 12x1200x2500	PROMAT	00014917	m ²	V13P85	25,14
PROMATECT 100 15x1200x2500	PROMAT	99147835	m ²	V13P85	31,75
PROMATECT 100 20x1200x2500	PROMAT	99147846	m ²	V13P85	41,90
PROMATECT 100 25x1200x2500	PROMAT	00014908	m ²	V13P85	52,37



Promat

PROMATECT 200 12x1200x2500	PROMAT	99147871	m ²	V13P85	-
PROMATECT 200 15x1200x2500	PROMAT	00014922	m ²	V13P85	-
PROMATECT 200 18x1200x2500	PROMAT	99147884	m ²	V13P85	-
PROMATECT 200 20x1200x2500	PROMAT	99147899	m ²	V13P85	-
PROMATECT 200 25x1200x2500	PROMAT	00014935	m ²	V13P85	-
PROMATECT 200 30x1200x2500	PROMAT	99147903	m ²	V13P85	-



Promat

PROMATECT H 6x1250x2500	PROMAT	99148005	m ²	V13P85	22,06
PROMATECT H 8x1250x2500	PROMAT	99148014	m ²	V13P85	27,69
PROMATECT H 10x1250x2500	PROMAT	00014946	m ²	V13P85	30,94
PROMATECT H 10x1250x3000	PROMAT	99147912	m ²	V13P85	30,98
PROMATECT H 12x1250x2500	PROMAT	99147927	m ²	V13P85	37,18
PROMATECT H 12x1250x3000	PROMAT	99147930	m ²	V13P85	37,13
PROMATECT H 15x1250x2500	PROMAT	99147941	m ²	V13P85	46,41
PROMATECT H 15x1250x3000	PROMAT	99147958	m ²	V13P85	46,41
PROMATECT H 20x1250x2500	PROMAT	99147965	m ²	V13P85	61,88
PROMATECT H 20x1250x3000	PROMAT	99147976	m ²	V13P85	61,88
PROMATECT H 25x1250x2500	PROMAT	99147989	m ²	V13P85	77,35
PROMATECT H 25x1250x3000	PROMAT	99147994	m ²	V13P85	77,35



Promat

Protección pasiva

PLACA PROTECCIÓN CONTRA EL FUEGO

PLACAS SILICATO CÁLCICO

Descripción	Fabricante	Código	U.V.	F. P.	PVP €
PROMATECT L 20x1200x2500	PROMAT	71658441	m ²	V13P85	53,85
PROMATECT L 25x1200x2500	PROMAT	99148029	m ²	V13P85	67,31
PROMATECT L 30x1200x2500	PROMAT	99148032	m ²	V13P85	80,77
PROMATECT L 40x1200x2500	PROMAT	00025276	m ²	V13P85	107,69



Promat

PRM PROMATECT S 9,5X1200X2500	PROMAT	1159769	m ²	V13P85	202,33
--------------------------------------	--------	----------------	----------------	--------	---------------



Promat

SELLADO

Descripción	Fabricante	Código	U.V.	F. P.	PVP €
① PASTA DE JUNTAS 20 kg	PROMAT	00012139	ud	V13P89	79,20
② PROMAFOAM CARTUCHO X UNIDAD	PROMAT	00032694	ud	V13P89	24,62
③ PROMASEAL A BLANCO 12 ud	PROMAT	03401284	ud	V13P89	86,64
④ PROMASTOP CC CUBO 12,5 kg	PROMAT	02322900	ud	V13P89	274,00
PROMASTOP I CUBO 12,5 kg	PROMAT	04764845	ud	V13P89	250,87
⑤ COLLARIN PROMASTOP FC6 50	PROMAT	03274163	ud	V13P89	116,96
COLLARIN PROMASTOP FC6 63	PROMAT	03274174	ud	V13P89	120,51
COLLARIN PROMASTOP FC6 75	PROMAT	03274192	ud	V13P89	123,35
COLLARIN PROMASTOP FC6 90	PROMAT	03274390	ud	V13P89	138,49
COLLARIN PROMASTOP FC6 110	PROMAT	03103298	ud	V13P89	139,82
COLLARIN PROMASTOP FC6 125	PROMAT	04998699	ud	V13P89	167,97
COLLARIN PROMASTOP FC6 160	PROMAT	71666444	ud	V13P89	171,04
COLLARIN PROMASTOP FC6 200	PROMAT	-	ud	V13P89	247,50
COLLARIN PROMASTOP FC6 250	PROMAT	04324414	ud	V13P89	342,56
COLLARIN PROMASTOP FC6 315	PROMAT	03575882	ud	V13P89	448,45
⑥ ALMOHADILLA PROMASTOP S (320x100x25)	PROMAT	03296402	ud	V13P89	19,84
ALMOHADILLA PROMASTOP L (320x200x35)	PROMAT	03296411	ud	V13P89	23,74
⑦ PROMASTOP U UNICOLLAR	PROMAT	99228875	ud	V13P89	154,31
⑧ PINTURA PROMAPAIN SC3 25 kg	PROMAT	01562185	ud	V13P89	409,75
PINTURA PROMAPAIN SC4 25 kg	PROMAT	02900753	ud	V13P89	413,75
⑨ PINTURA TOPCOAT F 20 kg	PROMAT	-	ud	V13P89	292,40
⑩ PINTURA PROMADUR 12,5 kg	PROMAT	-	ud	V13P89	344,62

Promat



①



②



③



④



⑤



⑥



⑦



⑧



⑨



⑩



SEGURIDAD CONTRA INCENDIOS

AISLAMIENTO TÉRMICO

		PANELES TECBOR®	
			MORTERO TECWOOL®
	SISTEMAS DE SELLADOS TECSEL®		
PINTURA TECLACK-W®			
			MORTERO TECPLASTER®

**PROTECCIÓN PASIVA
CONTRA INCENDIOS**

- | MORTEROS TECWOOL® |
- | PANELES TECBOR® |
- | SISTEMA DE SELLADOS TECSEL® |
- | PINTURA INTUMESCENTE TECLACK-W® |
- | MORTEROS TECPLASTER® |



Síguenos en



Parque Leganés Tecnológico LEGATEC - C/ Margarita Salas, 6 - 28918 Leganés - Madrid | Tel.: (+34) 91 428 22 60 | Fax: (+34) 91 428 22 62
 info@mercortecresa.com | www.mercortecresa.com

Protección pasiva

SELLADO

Descripción	Fabricante	Código	U.V.	F. P.	PVP €
① TECBOR PASTA JUNTAS PREPARADA 25 kg	TECRESA	99293189	ud	V13P89	375,00
TECBOR PASTA JUNTAS PREPARADA 12,5 kg	TECRESA	-	ud	V13P89	225,00
② PASTA DE JUNTAS TECBOR SACO 20 kg	TECRESA	71645045	ud	V13P89	40,00
③ PASTA DE AGARRE TECBOR SACO 25 kg	TECRESA	-	ud	V13P89	31,25
④ COLLARIN TECSEL EI-240 38 mm	TECRESA	72328561	ud	V13P89	35,00
COLLARIN TECSEL EI-240 40 mm	TECRESA	04989840	ud	V13P89	35,50
COLLARIN TECSEL EI-240 82 mm	TECRESA	72328615	ud	V13P89	50,00
COLLARIN TECSEL EI-240 90 mm	TECRESA	00957344	ud	V13P89	40,00
COLLARIN TECSEL EI-240 225 mm	TECRESA	72328752	ud	V13P89	235,00
COLLARIN TECSEL EI-240 250 mm	TECRESA	99303998	ud	V13P89	525,00
⑤ MULTICOLLARIN TECSEL DRM/2440 65x50x14 mm	TECRESA	71674104	ud	V13P89	140,00
⑥ MULTICOLLARIN MCR INTUMESCENTE TECSEL 2400x90x15 mm	TECRESA	71452638	ud	V13P89	100,00
BANDA INTUMESCENTE MCR 5000 mm	TECRESA	72329276	ud	V13P89	95,00
⑦ TCR MANGUITO TECSEL 110 mm	TECRESA	99263887	ud	V13P89	16,30
TCR MANGUITO TECSEL 125 mm	TECRESA	99263892	ud	V13P89	21,50
TCR MANGUITO TECSEL 160 mm	TECRESA	99263906	ud	V13P89	45,40
⑧ MASILLA INTUMESCENTE TECSEL INTERIOR 300ML BLANCO	TECRESA	72329294	cj	V13P89	5,50
⑨ TECSEL ESPUMA EI180 750 ml CANULA UNIDAD	TECRESA	99268325	ud	V13P89	15,00
⑩ SELLADOR FLEXIBLE TECSEL 40x20x1000	TECRESA	02879679	ud	V13P89	25,30
⑪ SAQUITOS INTUMESCENTES TECSEL 330x200x25	TECRESA	04390802	ud	V13P89	20,00
⑫ PINTURA IGNÍFUGA TECLACK-W	TECRESA	-	ud	V13P89	110,00



mercor
tecresa

Protección pasiva

REJILLAS

Descripción	Fabricante	Código	U.V.	F. P.	PVP €
 TECSEL 600x600	TECRESA	00032148	ud	V13P89	470,01
TECSEL 400x400	TECRESA	00035064	ud	V13P89	237,90
TECSEL DE 100x100 A 600x600 CADA 50 mm	TECRESA	-	ud	V13P89	CONSULTAR



MORTEROS EN YESO + PERLITA-VERMICULITA

Descripción	Fabricante	Código	U.V.	F. P.	PVP €
⑥ MORTERO PROTECCION PASIVA IGNIVER 18 Kg	PLACO	71468763	ud	V13P39	-
⑦ PROMIL IGNÍFUGO 20 Kg	YESOS MILLAN, S.L.	99314404	ud	V13P39	13,40
⑧ IGNIPLASTER 20 Kg	PROMAT	99147318	ud	V13P39	-



⑥



⑦



⑧



BASE LANA

Descripción	Fabricante	Código	U.V.	F. P.	PVP €
⑨ MORTERO PROMASPRAY F250 - FIBROFEU 20 Kg	PROMAT	00961912	ud	V13P39	40,20
⑩ MORTERO PROMASPRAY T - FIBREXPAN 20 Kg	PROMAT	00961927	ud	V13P39	38,40
⑪ MORTERO DE LANA ROCA F 25 Kg TECWOOL	TECRESA	99169745	ud	V13P39	31,60



⑨



⑩



⑪



OTROS

Descripción	Fabricante	Código	U.V.	F. P.	PVP €
⑫ MORTERO PROMASPRAY P300 20 Kg	PROMAT	71937854	ud	V13P39	35,60
⑬ MORTERO PROMASPRAY C450 12,5 Kg	PROMAT	-	ud	V13P39	19,12



⑫



⑬



Placas especiales

	Descripción	Fabricante	Código	U.V.	F. P.	PVP €
	HYDROPANEL 0BE 9x1200x2600	PROMAT	99270948	m²	V13P41	17,39
	HYDROPANEL 0BE 6X1200X2600	PROMAT	99258414	m²	V13P41	12,62
	HYDROPANEL 2BE 9x1200x2600	PROMAT	99065227	m²	V13P41	17,39
	HYDROPANEL 2BE 9x1200x3000	PROMAT	99065230	m²	V13P41	17,38
	HYDROPANEL 2BE 12x1200x2600	PROMAT	99065203	m²	V13P41	22,96
	HYDROPANEL 2BE 12x1200x3000	PROMAT	99065212	m²	V13P41	22,96
	HYDROPANEL 4BE 9x900x1200	PROMAT	99065241	m²	V13P41	27,79

Promat

	DURIPANEL B1 STD 10x1250x3100	EURONIT	99065018	m²	V13P41	12,16
	DURIPANEL B1 STD 12x1250x3100	EURONIT	99235482	m²	V13P41	14,12
	DURIPANEL B1 STD 20x1250x3100	EURONIT	99275253	m²	V13P41	22,84
	DURIPANEL B1 STD 32x1250x3100	EURONIT	99345714	m²	V13P41	41,45

Euronit

	HYDROPANEL RM FINISHER 15 Kg	PROMAT	99281267	ud	V13P20	49,89
	HYDROPANEL RM FINISHER 5 Kg	PROMAT	99270531	ud	V13P20	24,45
	HYDROPANEL RM PRIMER 5 Kg	PROMAT	99297417	ud	V13P20	27,71
	HYDROPANEL STRIP 50 mm 90 ml	PROMAT	99266963	rl	V13P20	6,68
	TORNILLOS HYDROPANEL HP 3,9x32 SP-PH2 500 ud	PROMAT	99279529	cj	V13P02	11,03
	TORNILLOS HYDROPANEL HP 3,9x47 SP-PH2 500 ud	PROMAT	99288008	cj	V13P02	14,08

Promat

FERMACELL FY STANDAR PF 12,5x1200x2600	FERMACELL	99305440	m²	V13P41	7,24
FERMACELL FY STANDAR PF 12,5x1200x3000	FERMACELL	99277846	m²	V13P41	7,24
FERMACELL FY STANDAR PF 15x1200x3000	FERMACELL	01544794	m²	V13P41	10,13
FERMACELL FY STANDAR PF 10x1200x3000	FERMACELL	99263944	m²	V13P41	6,13
FERMACELL FY STANDAR PF 12,5x1500x1000	FERMACELL	99279228	m²	V13P41	7,24
FERMACELL FY STANDAR PR 12,5x1200x3000 BA 2CA	FERMACELL	99269199	m²	V13P41	7,83



fermacell

① FERMACELL POWERPANEL H20 12,5z1200z2600	FERMACELL	99230487	m²	V13P41	21,41
TORNILLOS FERMACEL 3,9x35 mm POWERPANEL 500 ud	FERMACELL	99230492	cj	V13P02	29,76
FERMACELL PEGAMENTO JUNTAS CARTUCHO 310 ml	FERMACELL	99230508	ud	V13P02	12,47
FERMACELL PASTA JUNTAS 20 Kg/SACO	FERMACELL	99230517	ud	V13P02	38,34
FERMACEL CINTA VENDA 60 mm JUNTAS BA 45 ml/ud	FERMACELL	99280732	rl	V13P02	11,79



①

fermacell

Perfilería

PERFILERÍA PLACA YESO LAMINADO

RAILES

Descripción	Fabricante	Código	U.V.	F. P.	PVP €
RAIL 36x3000	PLACO	00019123	ml	V13P76	CONSULTAR
RAIL 48x3000	PLACO	00019136	ml	V13P75	CONSULTAR
RAIL 70x3000	PLACO	00019147	ml	V13P75	CONSULTAR
RAIL 90x3000	PLACO	00019154	ml	V13P76	CONSULTAR
RAIL 100x3000	PLACO	99143428	ml	V13P76	CONSULTAR
RAIL 125x3000	PLACO	99143431	ml	V13P76	CONSULTAR
RAIL 150x3000	PLACO	99143442	ml	V13P76	CONSULTAR

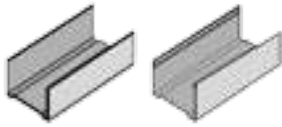

MONTANTE 36

Descripción	Fabricante	Código	U.V.	F. P.	PVP €
MONTANTE 36x3000	PLACO	00018951	ml	V13P76	CONSULTAR

MONTANTE 48

MONTANTE 48x2500	PLACO	99138585	ml	V13P75	CONSULTAR
MONTANTE 48x2600	PLACO	00018979	ml	V13P75	CONSULTAR
MONTANTE 48x2700	PLACO	99138651	ml	V13P75	CONSULTAR
MONTANTE 48x2800	PLACO	00018982	ml	V13P75	CONSULTAR
MONTANTE 48x3000	PLACO	00018997	ml	V13P75	CONSULTAR
MONTANTE 48x3500	PLACO	00011071	ml	V13P75	CONSULTAR
MONTANTE 48x4000	PLACO	00019024	ml	V13P75	CONSULTAR

MONTANTE 70

MONTANTE 70x2600	PLACO	00019048	ml	V13P75	CONSULTAR
MONTANTE 70x3000	PLACO	00019062	ml	V13P75	CONSULTAR
MONTANTE 70x3600	PLACO	00019073	ml	V13P75	CONSULTAR

MONTANTE 90

MONTANTE 90x3000	PLACO	00019086	ml	V13P76	CONSULTAR
-------------------------	-------	-----------------	----	--------	------------------

MONTANTE - OTROS

MONTANTE 100x4000	PLACO	99138284	ml	V13P76	CONSULTAR
MONTANTE 125x4000	PLACO	99138325	ml	V13P76	CONSULTAR
MONTANTE 150x4000	PLACO	99138426	ml	V13P76	CONSULTAR



Perfilería

PERFILERÍA PLACA YESO LAMINADO

PERFILERÍA PARA TECHO CONTINUO Y SEMITABIQUE

Descripción	Fabricante	Código	U.V.	F. P.	PVP €
① F530 3000 mm	PLACO	00013404	ml	V13P75	CONSULTAR
② F530 5300 mm	PLACO	99134466	ml	V13P75	CONSULTAR
③ CLIP METALICO FUEGO F530 100 ud	PLACO	04888097	cj	V13P75	CONSULTAR
④ RIGI 60x3000	PLACO	00013051	ml	V13P76	CONSULTAR
⑤ RIGI 60x4000	PLACO	99143617	ml	V13P76	CONSULTAR
⑥ STIL PRIM 50x4000	PLACO	00019109	ml	V13P76	CONSULTAR
⑦ ÁNGULO CR2x3000	PLACO	00013365	ml	V13P75	CONSULTAR
⑧ PERFIL PCEX2400	PLACO	00012252	ml	V13P75	CONSULTAR
⑨ OMEGA MAESTRA 3000	PLACO	00012823	ml	V13P75	CONSULTAR
⑩ PERFIL U 0,55x(25x29x25)x2400	PLACO	00012252	ml	V13P75	CONSULTAR
⑪ STIL PRIM 100 P50x4000	PLACO	00019091	ml	V13P76	CONSULTAR
⑫ STIL PRIM 100 P60x3000	PLACO	99143888	ml	V13P76	CONSULTAR
⑬ STIL PRIM 100 P60x4200	PLACO	99143893	ml	V13P76	CONSULTAR
⑭ STIL PRIM 100 P60x4800	PLACO	00014481	ml	V13P76	CONSULTAR

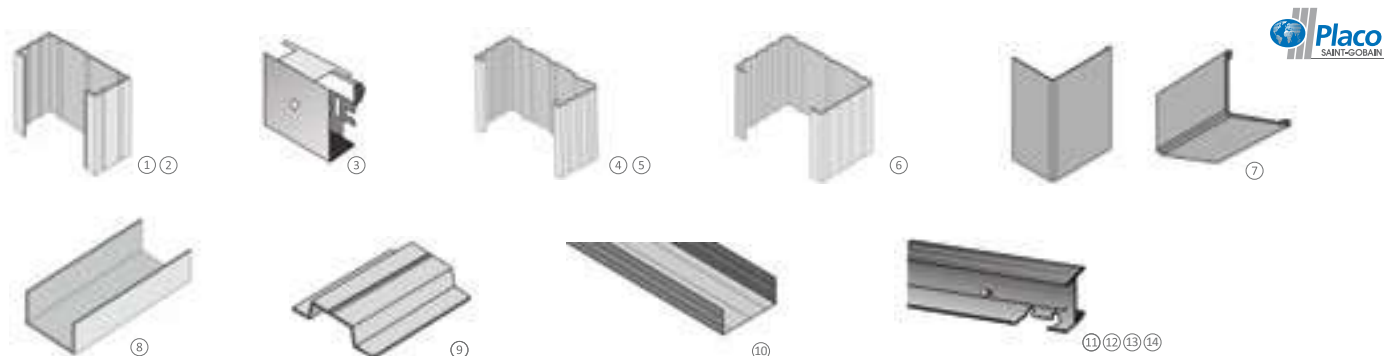

ACCESORIOS TECHOS F-530

Descripción	Fabricante	Código	U.V.	F. P.	PVP €
① HORQUILLA F530	PLACO	00009281	cj	V13P76	CONSULTAR
② HORQUILLA RÁPIDA F530	PLACO	99318194	cj	V13P76	CONSULTAR
③ EMPALME F530	PLACO	00013477	cj	V13P76	CONSULTAR
④ CRUCETA EMPALME F530	PLACO	99317728	cj	V13P76	CONSULTAR
⑤ SUSPENSIÓN CORTA 100 ud	PLACO	00019369	cj	V13P76	CONSULTAR
⑥ SUSPENSIÓN LARGA 100 ud	PLACO	00019370	cj	V13P76	CONSULTAR
⑦ SUSPENSIÓN MÁXIMA 100 ud	PLACO	00019383	cj	V13P76	CONSULTAR
⑧ CLIP F530	PLACO	99132860	cj	V13P76	CONSULTAR
⑨ GRAPA ARTICULADA 4 -10 (CAJA 100 ud)	PLACO	99317704	cj	V13P76	CONSULTAR
⑩ GRAPA ARTICULADA 10 -15 (CAJA 100 ud)	PLACO	99317713	cj	V13P76	CONSULTAR

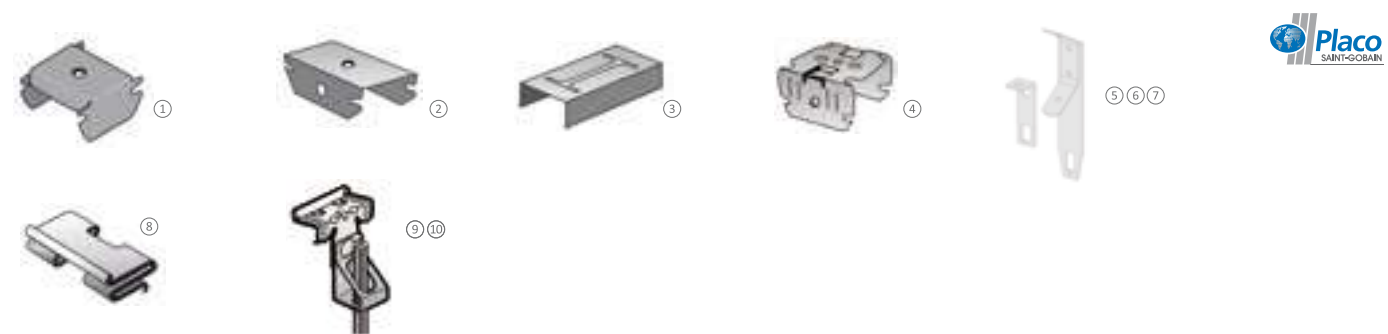

Perfilería

PERFILERÍA PLACA YESO LAMINADO

ACCESORIOS TECHOS RIGI 60

Descripción	Fabricante	Código	U.V.	F. P.	PVP €
11 HORQUILLA RIGI60 50 ud	PLACO	99345642	cj	V13P76	CONSULTAR
12 EMPALME RIGI60	PLACO	99324568	cj	V13P76	CONSULTAR
13 CRUCETA DE EMPALME RIGI60 25 ud	PLACO	00036306	cj	V13P76	CONSULTAR
14 HORQUILLA TC-60	INGEPERFIL	99327653	cj	V13P48	CONSULTAR
15 EMPALME TC-60	INGEPERFIL	99327699	cj	V13P48	CONSULTAR



ACCESORIOS STIL PRIM 100

16 EMPALME STILPRIM 50 ud	PLACO	00013495	cj	V13P76	CONSULTAR
17 SUSPENSIÓN STIL PRIM 100 1/4 VUELTA 50 ud	PLACO	99290070	cj	V13P76	CONSULTAR
EMPALME MULTIPRIM 5 ud	PLACO	00019408	cj	V13P76	CONSULTAR
SUSPENSIÓN MULTIPRIM 25 ud	PLACO	99144021	cj	V13P76	CONSULTAR
TENSOR 25 ud	PLACO	99144179	cj	V13P76	CONSULTAR



SISTEMA HIGH-STIL PARA GRANDES ALTURAS

Descripción	Fabricante	Código	U.V.	F. P.	PVP €
RAIL HIGH STIL 70x4000	PLACO	99377430	ml	V13P76	CONSULTAR
RAIL HIGH STIL 100x4000	PLACO	00042462	ml	V13P76	CONSULTAR



SISTEMA HIGH-STIL PARA GRANDES ALTURAS - MONTANTES

MONTANTE HIGHSTIL 70x4000	PLACO	01236323	ml	V13P76	CONSULTAR
MONTANTE HIGHSTIL 70x4500	PLACO	99377717	ml	V13P76	CONSULTAR
MONTANTE HIGHSTIL 70x5000	PLACO	99377441	ml	V13P76	CONSULTAR
MONTANTE HIGHSTIL 70x5630	PLACO	00022787	ml	V13P76	CONSULTAR
MONTANTE HIGHSTIL 70x5980	PLACO	00022774	ml	V13P76	CONSULTAR
MONTANTE HIGHSTIL 70x6000	PLACO	99377458	ml	V13P76	CONSULTAR
MONTANTE HIGHSTIL 70x6100	PLACO	99377722	ml	V13P76	CONSULTAR
MONTANTE HIGHSTIL 70x6500	PLACO	00023454	ml	V13P76	CONSULTAR
MONTANTE HIGHSTIL 70 LARGO VARIABLE	PLACO	00949794	ml	V13P76	CONSULTAR
MONTANTE HIGHSTIL 100x9250	PLACO	00042534	ml	V13P76	CONSULTAR



Perfilería

SISTEMA HIGH-STIL PARA GRANDES ALTURAS

Descripción	Fabricante	Código	U.V.	F. P.	PVP €
EMPALME HIGH STIL 100	PLACO	00042507	ml	V13P76	CONSULTAR
EMPALME HIGH STIL 70	PLACO	99377735	ml	V13P76	CONSULTAR



RIOSTRA HIGH STIL 70	PLACO	04976697	ml	V13P76	CONSULTAR
RIOSTRA MEGASTIL/HIGH STIL EQC 100x300 mm	PLACO	00042491	ml	V13P76	CONSULTAR



SISTEMA PROTECCION PASIVA SHAFTWALL

Descripción	Fabricante	Código	U.V.	F. P.	PVP €
PLACA YESO COREBOARD 19x600x3000	PLACO	99132927	m²	V13P80	24,07
PLACA YESO PPF 15x1200x2500	PLACO	00014115	m²	V13P49	10,57
PLACA YESO PPF 15x1200x3000	PLACO	00014133	m²	V13P49	10,57
MONTANTE SHAFTWALL 60I70 0,7x3600	PLACO	99139009	ml	V13P76	CONSULTAR
MONTANTE SHAFTWALL 60I70 0,7x4200	PLACO	99139018	ml	V13P76	CONSULTAR
PERFIL FIJACION SHAFTWALL G102 2400	PLACO	99139900	ml	V13P76	CONSULTAR
RAIL ARRANQUE SHAFTWALL 60SC55 3600	PLACO	99143466	ml	V13P76	CONSULTAR
RAIL SUELO SHAFTWALL 62C50 3600	PLACO	99143510	ml	V13P76	CONSULTAR
RAIL SUPERIOR SHAFTWALL 62JC70 3600	PLACO	99143525	ml	V13P76	CONSULTAR
ANGULAR SHAFTWALL GA 3 0,7x3x3200	PLACO	99131467	ml	V13P76	CONSULTAR
BANDA ANTIFUEGO FIRESTRIP 3600 mm 5UD/CJ	PLACO	99132149	cj	V13P95	65,50
SELLADORA SEALANT 0,60 l	PLACO	71554639	ud	V13P95	110,89

SISTEMA ZONAS HUMEDAS

Descripción	Fabricante	Código	U.V.	F. P.	PVP €
PERFIL HYDROSTIL R 48 48x3000	PLACO	03822515	ml	V13P76	CONSULTAR
PERFIL HYDROSTIL M 48 48x3000	PLACO	03822742	ml	V13P76	CONSULTAR
PERFIL HYDROSTIL R 70 70x3000	PLACO	03109098	ml	V13P76	CONSULTAR
PERFIL HYDROSTIL M 70 70x3000	PLACO	03108695	ml	V13P76	CONSULTAR
PERFIL HYDROSTIL F 530 45x16x3000	PLACO	04984373	ml	V13P76	CONSULTAR

SISTEMA ACÚSTICO

Descripción	Fabricante	Código	U.V.	F. P.	PVP €
MONTANTE METALPHONIQUE 0,6x48x3000	PLACO	99139601	ml	V13P76	CONSULTAR
MONTANTE METALPHONIQUE 0,6x48x4000	PLACO	04821593	ml	V13P76	CONSULTAR

Perfilería

COMPLEMENTOS PERFIL

CHAPA PARA TABIQUE BLINDADO

Descripción	Fabricante	Código	U.V.	F. P.	PVP €
CHAPA ANTIVANDÁLICA 0,6x1250x300 GALVA	INGEPERFIL	99079394	m ²	V13P48	CONSULTAR
CHAPA ANTIVANDÁLICA 0,6x1200x1250 GALVA	INGEPERFIL	99079389	m ²	V13P48	CONSULTAR



SOPORTE DE CARGA

Descripción	Fabricante	Código	U.V.	F. P.	PVP €
SOPORTE DE CARGA 200-400	PLACO	99269018	ud	V13P76	CONSULTAR
SOPORTE DE CARGA 290-400	PLACO	99143839	cj	V13P76	CONSULTAR
SOPORTE DE CARGA 200-600	PLACO	99143826	cj	V13P76	CONSULTAR
SOPORTE DE CARGA 290-600	PLACO	99143840	ud	V13P76	CONSULTAR
SOPORTE DE CARGA 0,8x400x200 SIMPLE	INGEPERFIL	02021636	ud	V13P48	CONSULTAR
SOPORTE DE CARGA 0,8x600x200 SIMPLE	INGEPERFIL	00042521	ud	V13P48	CONSULTAR



ESQUINEROS (GUARDAVIVOS)

Descripción	Fabricante	Código	U.V.	F. P.	PVP €
① ESQUINERO METÁLICO 2500	PLACO	99134358	ml	V13P76	CONSULTAR
② ESQUINERO PLÁSTICO 2500	PLACO	99134365	ml	V13P76	CONSULTAR
③ ESQUINERO FLEXIBLE OPTIMUS 30 ml	PLACO	72328260	rl	V13P95	42,29
④ ESQUINERO FLEXIBLE AQUABEAD 25 ml	PLACO	72328338	rl	V13P95	55,68



PERFIL PARA PLACA FERMACELL

Descripción	Fabricante	Código	U.V.	F. P.	PVP €
MONTANTE CW-50/50 2600	INGEPERFIL	00041481	ml	V13P48	CONSULTAR
MONTANTE CW-50/50 3000	INGEPERFIL	00041496	ml	V13P48	CONSULTAR
MONTANTE CW-75/50 2600	INGEPERFIL	00041502	ml	V13P48	CONSULTAR
MONTANTE CW-75/50 3000	INGEPERFIL	00041511	ml	V13P48	CONSULTAR
RAIL UW-50/40 3000	INGEPERFIL	00041526	ml	V13P48	CONSULTAR
RAIL UW-75/40 3000	INGEPERFIL	00041539	ml	V13P48	CONSULTAR

Pastas en polvo

Soluciones Placo

RÁPIDA 1/2 H



Descripción	Fabricante	Código	U.V.	F. P.	PVP €
PASTA JUNTAS PR 30 10 kg	PLACO	00032038	ud	V13P93	15,24
PASTA JUNTAS PR 30 25 kg	PLACO	99327237	ud	V13P93	32,06



RÁPIDA 1H



PASTA JUNTAS PR1 25 kg NF	PLACO	00014432	ud	V13P93	32,39
---------------------------	-------	----------	----	--------	-------



RÁPIDA 2H



PASTA JUNTAS PR2 25 kg NF	PLACO	00014443	ud	V13P93	31,11
---------------------------	-------	----------	----	--------	-------



RÁPIDA 4H



PASTA JUNTAS PR4 25 kg NF	PLACO	00014450	ud	V13P93	31,64
---------------------------	-------	----------	----	--------	-------



LENTA 24H



PASTA JUNTAS SN 25 kg NF	PLACO	00014467	ud	V13P93	31,75
--------------------------	-------	----------	----	--------	-------



AGARRE



PASTA AGARRE ADH 25 kg	PLACO	00002426	ud	V13P93	16,29
PLC PASTA AGARRE MAP 25 kg	PLACO	00011314	ud	V13P93	17,55



ESPECIALES



PASTA JUNTAS PLACOFINISH 25 kg	PLACO	00014045	ud	V13P93	20,90
PASTA JUNTAS PR HYDRO 25 kg	PLACO	2939348	ud	V13P93	36,92



Pastas en polvo

Soluciones Ultipro

①	PASTA JUNTAS LENTA ULTIPTRO SACO 25 kg	ULTIPRO	05002212	sac	V13P94	31,75
②	PASTA JUNTAS RAPIDA 1/2 H ULTIPTRO BOLSA 5 kg	ULTIPRO	05002227	sac	V13P94	7,62
③	PASTA AGARRE ULTIPTRO SACO 25 kg	ULTIPRO	05002230	sac	V13P94	16,29
④	PASTA JUNTAS RAPIDA 2 H ULTIPTRO SACO 25 kg	ULTIPRO	71388731	sac	V13P94	31,11



①



②



③



④



Soluciones Semin

RÁPIDA 1/2 H

Descripción	Fabricante	Código	U.V.	F. P.	PVP €
PASTA JUNTAS RÁPIDA CE 78 1/2 h 25 kg	SEMIN	99127527	ud	V13P94	31,28



RÁPIDA 1H

PASTA JUNTAS RÁPIDA CE 78 1 h 25 kg	SEMIN	99127512	ud	V13P94	31,60
-------------------------------------	-------	----------	----	--------	-------



RÁPIDA 4H

PASTA JUNTAS CE 78 4 h RAPI	SEMIN	99127479	ud	V13P94	30,87
-----------------------------	-------	----------	----	--------	-------



Otras Soluciones

Descripción	Fabricante	Código	U.V.	F. P.	PVP €
HYDROANEL RM FINISHER 15 kg	PROMAT	99281267	ud	V13P20	49,89
HYDROANEL RM FINISHER 5 kg	PROMAT	99270531	ud	V13P20	24,45



Euronit

A large elephant is shown from a top-down perspective, walking towards the viewer. The elephant's trunk is slightly curved to the left. The background is a solid blue color.

SEMIN

Ventajas
ENORMES

Nueva gama Plakist



Pastas preparadas

Soluciones Placo

Descripción	Fabricante	Código	U.V.	F. P.	PVP €
① PROMIX PRO 20 kg	PLACO	99270452	ud	V13P93	30,30
② PROMIX PRO 6 kg	PLACO	72200267	ud	V13P93	12,28
PASTA JUNTAS PROMIX HYDRO 11 kg	PLACO	00960715	ud	V13P93	74,98
PASTA JUNTAS PREPARADA PROMIX XROC 20 kg	PLACO	72458181	ud	V13P81	66,93



Soluciones Ultipro

Descripción	Fabricante	Código	U.V.	F. P.	PVP €
③ PASTA JUNTAS PREPARADA ULTIPTRO BOTE 25 kg	ULTIPRO	05002241	ud	V13P94	30,30
④ PASTA JUNTAS PREPARADA ULTIPTRO BOTE 7 kg	ULTIPRO	05002258	ud	V13P94	12,28



Soluciones Semin

Descripción	Fabricante	Código	U.V.	F. P.	PVP €
⑤ PASTA PREPARADA CE78 PLAKIST TAPA VERDE 25 kg	SEMIN	72459902	ud	V13P94	36,95



Soluciones Sheetrock

Descripción	Fabricante	Código	U.V.	F. P.	PVP €
PASTA PREPARADA FILL&FINISH 20 kg	KNAUF INTERIORS	00020217	ud	V13P94	29,18
PASTA PREPARADA FILL&FINISH LIGHT 20 kg	KNAUF INTERIORS	04982638	ud	V13P94	37,53



Renovación

Descripción	Fabricante	Código	U.V.	F. P.	PVP €
⑦ PLACOSTIC ESTANDAR EN POLVO 15 kg/SC	PLACO	00045216	ud	V13P02	18,64
⑧ PLACOSTIC RENOVACIÓN EN POLVO 15 kg/SC	PLACO	00045221	ud	V13P02	18,44



Accesorios

CINTAS

Descripción	Fabricante	Código	U.V.	F. P.	PVP €
CINTA JUNTAS 150 m GR	PLACO	00005784	rl	V13P95	9,08
CINTA MALLA PLACOFINISH 90 ml	PLACO	99132822	rl	V13P95	5,81
CINTA FIBRA VIDRIO 50mmx25m	PLACO	72290808	rl	V13P95	2,55
CINTA GUARDAVIVOS 30 ml	PLACO	00005760	rl	V13P95	24,34
BANDA ESTANCA 45 30 ml ROLLO	PLACO	99132163	rl	V13P95	11,96
BANDA ESTANCA 70 30 ml ROLLO	PLACO	99132174	rl	V13P95	16,28
BANDA ANTIFUEGO FIRESTRIP 3600 mm 5un/cj	PLACO	99132149	cj	V13P95	65,50

① CINTA JUNTAS 150 m ULTI PRO	ULTIPRO	05002199	rl	V13P02	9,08
② CINTA GUARDAVIVOS 30 m ULTI PRO	ULTIPRO	05002203	rl	V13P02	24,34
③ BANDA ESTANCA 45 mm x 30 ml ULTI PRO	ULTIPRO	71406323	rl	V13P02	11,96
④ BANDA ESTANCA 65 mm x 30 ml ULTI PRO	ULTIPRO	71406309	rl	V13P02	16,28



①



②



③



④

ULTI PRO

Descripción	Fabricante	Código	U.V.	F. P.	PVP €
HYDROPANEL STRIP 50 mm 90 ml	PROMAT	99266963	ud	V13P41	6,68
ROLLO CINTA MALLA 10 cm x 45 m 1,2 m/m ²	PROMAT	99322342	ud	V13P20	7,07

PERFILES PLACOLISTEL

Descripción	Fabricante	Código	U.V.	F. P.	PVP €
PLACOLISTEL 105 3000	PLACO	99141589	ml	V13P95	9,88
PLACOLISTEL 106 3000	PLACO	99141594	ml	V13P95	8,21
PLACOLISTEL 119 3000	PLACO	99141655	ml	V13P95	8,30



Placo
LAMPARILLAS

PERFILES

Descripción	Fabricante	Código	U.V.	F. P.	PVP €
① PERFIL ESQUINA PVC 3776 ACABADO CURVO 3,05 ml	PROTEKTOR	72734683	ml	V13P02	1,60
② PERFIL ESQUINA PVC 3780 INTERIOR PROTEJE 3,05 ml	PROTEKTOR	72734698	ml	V13P02	1,88
③ PERFIL JUNTA DILATACIÓN PVC 37509 +1/-1 mm ROLLO 25 ml	PROTEKTOR	72734708	ml	V13P02	1,84
④ PERFIL JUNTA DILATACIÓN PVC 3755 +2/-2 mm 3,05 ml	PROTEKTOR	72734717	ml	V13P02	2,79
⑤ PERFIL JUNTA DILATACIÓN GALVA 3226 +5/-2 mm 3 ml	PROTEKTOR	72734722	ml	V13P02	17,57
⑥ PERFIL SOMBRA EN Z GALVA 1751 20 mm 3 ml	PROTEKTOR	72734735	ml	V13P02	2,21
⑦ PERFIL SOMBRA EN Z GALVA 1753 15 mm 3 ml	PROTEKTOR	72734746	ml	V13P02	2,16
⑧ PERFIL SOMBRA EN Z GALVA PLUS 1750 3 ml	PROTEKTOR	72734753	ml	V13P02	2,31
⑨ PERFIL SOMBRA EN Z PVC 3782 12 mm 3,05 ml	PROTEKTOR	72734760	ml	V13P02	1,77
⑩ PERFIL SOMBRA EN Z PVC 3783 18 mm 3,05 ml	PROTEKTOR	72734771	ml	V13P02	1,84
⑪ PERFIL SOMBRA 20MM GALVA 1313 PLACA 12,5 3 ml	PROTEKTOR	72734784	ml	V13P02	3,63
⑫ PERFIL SOMBRA 20MM GALVA 1315 PLACA 15 3 ml	PROTEKTOR	72734799	ml	V13P02	3,78

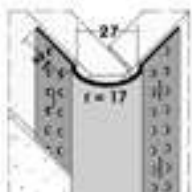

①



②



③



④



⑤



⑥

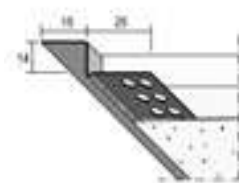

⑦

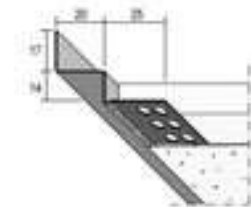

⑧

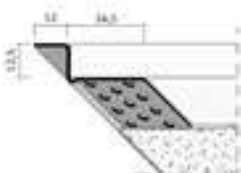

⑨

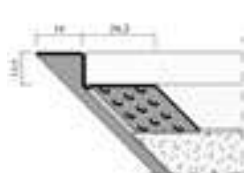

⑩



⑪



⑫

Accesorios

NOVEDAD

PERFILES

Descripción	Fabricante	Código	U.V.	F. P.	PVP €
13 PERFIL CIERRE EMPLASTECER ALU 9299 PLACA 12,5 2,5 ml	PROTEKTOR	72734801	ml	V13P02	0,69
14 PERFIL CIERRE EMPLASTECER ALU 9297 PLACA 15 2,5 ml	PROTEKTOR	72734810	ml	V13P02	0,71
15 PERFIL CIERRE EMPLASTECER ALU 9002 PLACA 25 2,5 ml	PROTEKTOR	72734825	ml	V13P02	1,11
16 PERFIL CIERRE EMPLASTECER PVC 3786 PLACA 13 3,05 ml	PROTEKTOR	72734838	ml	V13P02	1,01
17 PERFIL CIERRE EMPLAST GALVA 1234 14x22 PLACA 12,5 2,5 ml	PROTEKTOR	72734849	ml	V13P02	1,13
18 PERFIL CIERRE GALVA 1131 PLACA 12,5 2,5 ml	PROTEKTOR	72734856	ml	V13P02	2,05
19 PERFIL CIERRE ENCAJAR PVC 3787 PLACA 12,5 3,05 ml	PROTEKTOR	72734863	ml	V13P02	1,22
20 PERFIL REMATE PVC 3766 3 ml	PROTEKTOR	72734874	ml	V13P02	1,25
21 PERFIL CIERRE EMPLAST PVC 3785 PLACA 13 TIRA 3,05 ml	PROTEKTOR	72734887	ml	V13P02	1,47
22 PERFIL ESQUINA 3767 PARA CURVAS 3 ml	PROTEKTOR	72734892	ml	V13P02	1,58
23 PERFIL ESQUINA PVC 3778 PROTEJE CURVAS 3,05 ml	PROTEKTOR	72734906	ml	V13P02	2,17
24 PERFIL CIERRE PVC 3768 PARA CURVAS TECHO CONTINUO 3 ml	PROTEKTOR	72734915	ml	V13P02	1,51
25 PERFIL CIERRE PVC 3769 PARA CURVAS TECHO REGIST 2,5 ml	PROTEKTOR	72734920	ml	V13P02	3,98

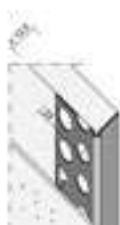

13



14



15



16



17



18

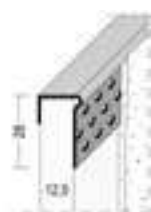

19



20



21



22



23

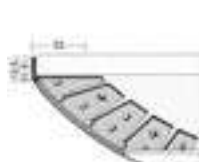

24



25

Accesorios

TORNILLOS

ULTIPRO

Descripción	Fabricante	Código	U.V.	F. P.	PVP €
TTPC 3,5x25 mm (caja 1.000 ud)	ULTIPRO	05002265	cj	V13P02	8,75
TTPC 3,5x35 mm (caja 1.000 ud)	ULTIPRO	05002276	cj	V13P02	11,83
TTPC 3,5x45 mm (caja 1.000 ud)	ULTIPRO	05002294	cj	V13P02	15,00
TRPF 3,5x9,5 mm (caja 200 ud)	ULTIPRO	05002289	cj	V13P02	3,55
TRPF 3,5x13 mm (caja 500 ud)	ULTIPRO	71388742	cj	V13P02	10,33

SEMIN

TTPC55 AUTOROSCANTE (caja 500 ud)	SEMIN	99237538	cj	V13P02	9,88
TTPC70 AUTOROSCANTE (caja 500 ud)	SEMIN	99314428	cj	V13P02	15,77
TTPC90 AUTOROSCANTE (caja 500 ud)	SEMIN	99314431	cj	V13P02	30,40

PLACO

TTPF25 1.000 ud	PLACO	00019231	cj	V13P95	15,09
TTPF35 1.000 ud	PLACO	99144313	cj	V13P95	17,93
TRPF 13 500 ud	PLACO	00021809	cj	V13P95	10,33
THTPF 25 mm 500 ud	PLACO	03427424	cj	V13P95	20,86
THTPF 38 mm 500 ud	PLACO	03427666	cj	V13P95	27,92
PM HABITO 3,5x35 mm 250 ud/bolsa	PLACO	72371921	ud	V13P95	12,86
RIGIDUR 3,5x30 1.000 ud	PLACO	00944238	cj	V13P95	24,01
RIGIDUR 3,5x40 1.000 ud	PLACO	02098988	cj	V13P95	34,20
XROC 25 mm	PLACO	72381047	cj	V13P95	4,59
XROC 35 mm	PLACO	72381054	cj	V13P95	6,21
XROC 45 mm	PLACO	72381061	cj	V13P95	8,87
RIGI 3,5x30 mm 500 ud/caja	PLACO	99144210	cj	V13P95	14,78



OTROS

HYDRO. HP 3,9x32-SP-PH2 500 ud	PROMAT	99279529	cj	V13P02	11,03
HYDRO. HP 3,9x47SP-PH2 500 ud	PROMAT	99288008	cj	V13P02	14,08
FERMACEL 3,9x35 mm POWERP. 500 ud	FERMACELL	99230492	cj	V13P02	29,76

Accesorios

TRAMPILLAS

Descripción	Fabricante	Código	U.V.	F. P.	PVP €
① TRAMPILLA PLACA ALUMINO PPM 12,5x200x200	ULTIPRO	04994183	ud	V13P20	42,30
② TRAMPILLA PLACA ALUMINO PPM 12,5x300x300	ULTIPRO	04994198	ud	V13P20	47,90
③ TRAMPILLA PLACA ALUMINO PPM 12,5x400x400	ULTIPRO	71406215	ud	V13P20	54,65
④ TRAMPILLA PLACA ALUMINO PPM 12,5x500x500	ULTIPRO	04994226	ud	V13P20	54,65
⑤ TRAMPILLA PLACA-ALUMINO PPM 12,5x600x600	ULTIPRO	71406244	ud	V13P20	71,45
⑥ TRAMPILLA PLACA-ALUMINO PPM 12,5x1200x600	ULTIPRO	71388713	ud	V13P20	99,28
⑦ TRAMPILLA METALICA LACADA 200x200	ULTIPRO	05035575	ud	V13P20	37,60
⑧ TRAMPILLA METALICA LACADA 300x300	ULTIPRO	04994169	ud	V13P20	46,60
⑨ TRAMPILLA METALICA LACADA 400x400	ULTIPRO	71406282	ud	V13P20	55,45
⑩ TRAMPILLA METALICA LACADA 500x500	ULTIPRO	04994170	ud	V13P20	65,80
⑪ TRAMPILLA METALICA LACADA 600x600	ULTIPRO	71406297	ud	V13P20	77,40



① ② ③ ④ ⑤ ⑥



⑦ ⑧ ⑨ ⑩ ⑪



TRAMPILLAS RF Y ESTANCAS

NOVEDAD

TRAMPILLA MET TECHO RF 400x400 ALUMATIC EI60 30 mm	SEMIN	72470831	ud	V13P20	150,51
TRAMPILLA MET TECHO RF 600x600 ALUMATIC EI60 30 mm	SEMIN	72470842	ud	V13P20	208,17
TRAMPILLA MET TECHO RF 400x400 ALUMATIC EI90 2x25 mm	SEMIN	72470859	ud	V13P20	257,94
TRAMPILLA MET TECHO RF 600x600 ALUMATIC EI90 2x25 mm	SEMIN	72470866	ud	V13P20	313,43
TRAMPILLA MET TECHO RF 400x400 SECUTECHNA EI120 2x25	SEMIN	72470880	ud	V13P20	310,71
TRAMPILLA MET TECHO RF 600x600 SECUTECHNA EI120 2x25	SEMIN	72470923	ud	V13P20	440,54
TRAMPILLA MET ESTANCA ALUQUATTRO 600x600 12,5 mm	SEMIN	72470936	ud	V13P20	200,06



①



②



③



④

Accesorios

COMPLEMENTOS

Descripción	Fabricante	Código	U.V.	F. P.	PVP €
BALDA PCR 300	GERMANS ALMIRÓN	00986212	ml	V13P20	17,55
BALDA PCR 400	GERMANS ALMIRÓN	01086946	ml	V13P20	20,78
BALDA PCR 600	GERMANS ALMIRÓN	01086953	ml	V13P20	28,29
BALDA PCR 500	GERMANS ALMIRÓN	00986227	ml	V13P20	25,77



MOLDURAS DE PLACA CARTÓN YESO A CONSULTAR

EUROFINST

Fachadas ventiladas

BLUCLAD

Descripción	Fabricante	Código	U.V.	F. P.	PVP €
PLACA BLUCLAD MD 10x1250x2500	PROMAT	99065320	m ²	V13P41	27,49
PLACA BLUCLAD MD 10x1250x2850	PROMAT	99241522	m ²	V13P41	26,73



Promat

REVOCO DECORATIVO BLUCLAD	PROMAT	00907141	ud	V13P20	66,24
MORTERO JUNTAS BLUCLAD 20	PROMAT	99316383	ud	V13P39	33,53
PINTURA ELÁSTICA BLUCLAD C1	PROMAT	99367644	ud	V13P20	132,38

NATURA

Descripción	Fabricante	Código	U.V.	F. P.	PVP €
① NATURA BASE ANTRACITA 3130x1280x8 NO73	EURONIT	00023243	m ²	V13P41	77,57
② NATURA BASE ANTRACITA 3130x1280x8 NO71	EURONIT	00023278	m ²	V13P41	75,35
③ NATURA BASE ANTRACITA 3130x1280x8 N283	EURONIT	00023281	m ²	V13P41	75,35
④ NATURA BASE ANTRACITA 3130x1280x8 N251	EURONIT	99300061	m ²	V13P41	65,97
⑤ NATURA GRIS NATURAL 3130x1280x8 N250	EURONIT	99292766	m ²	V13P41	50,45
⑥ NATURA PRO GRIS NATURAL NU 250 2530x1280x8	EURONIT	00956576	m ²	V13P41	61,28
⑦ NATURA PRO GRIS NATURAL NU 250 3130x1280x8	EURONIT	00956589	m ²	V13P41	61,28
⑧ NATURA PRO BLANCO CREMA NU 154 2530x1280x8	EURONIT	00956594	m ²	V13P41	114,85
⑨ NATURA PRO BLANCO CREMA NU 154 3130x1280x8	EURONIT	00956600	m ²	V13P41	114,85
⑩ NATURA PRO BLANCO NU191 2530x1280x8	EURONIT	00957351	m ²	V13P41	63,04
⑪ NATURA PRO BLANCO NU191 3130x1280x8	EURONIT	00957368	m ²	V13P41	63,00

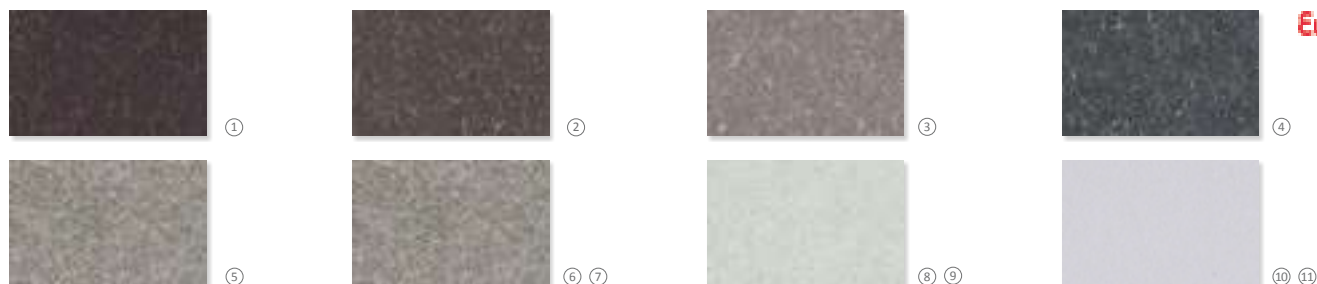

EURONIT

Fachadas ventiladas

TECTIVA

Descripción	Fabricante	Código	U.V.	F. P.	PVP €
① TECTIVA BLANCO 8x1240x3070	EURONIT	00947808	m ²	V13P41	39,32
② TECTIVA BLANCO 8x1240x2520	EURONIT	01591798	m ²	V13P41	39,32
③ TECTIVA GRIS TE20 8x1240x2520	EURONIT	00958871	m ²	V13P41	40,51
④ TECTIVA GRIS TE20 8x1240x3070	EURONIT	00958884	m ²	V13P41	40,51



① ②



③ ④

Éuronit

PICTURA

Descripción	Fabricante	Código	U.V.	F. P.	PVP €
⑤ PANEL PICTURA 2530x1280x8 BEIGE PU 842	EURONIT	00030960	m ²	V13P41	70,14
⑥ PANEL PICTURA 3130x1280x8 BEIGE PU 842	EURONIT	00030971	m ²	V13P41	70,14
PANEL PICTURA 2530x1280x8 VERDE PU 542	EURONIT	00031015	m ²	V13P41	75,17
PANEL PICTURA 3 130x1280x8 VERDE PU 542	EURONIT	00031006	m ²	V13P41	75,17
⑦ PANEL PICTURA 2530x1280x8 VERDE PU 543	EURONIT	00031033	m ²	V13P41	75,17
⑧ PANEL PICTURA 3130x1280x8 VERDE PU 543	EURONIT	00031020	m ²	V13P41	75,17
⑨ PANEL PICTURA 3130x1280x8 VERDE PU 541	EURONIT	00030984	m ²	V13P41	77,57



⑤ ⑥

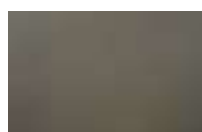

⑦ ⑧



⑨

Éuronit

CEDRAL

Descripción	Fabricante	Código	U.V.	F. P.	PVP €
⑩ TABLÓN CEDRAL STD 10x190x3600 C08 CED ARENA	EURONIT	00025764	ud	V13P41	23,04
⑪ TABLÓN CEDRAL STD 10x190x3600 C07 BLCO-CREMA	EURONIT	00025793	ud	V13P41	23,04
⑫ TABLÓN CEDRAL STD 10x190x3600 C01 BLANCO	EURONIT	00026341	ud	V13P41	23,04
⑬ TABLÓN CEDRAL STD 10x190x3600 C02 CED BEIGE	EURONIT	99375414	ud	V13P41	23,04
⑭ TABLÓN CEDRAL STD 10x190x3600 C50 NEGRO CEDAR	EURONIT	00025896	ud	V13P41	23,04
⑮ TABLÓN CEDRAL MAD 10x190x360 CL100RC NOGAL	EURONIT	99323055	ud	V13P41	26,92
⑯ TABLÓN CEDRAL MAD 10x190x3600 ROBLE CLARO	EURONIT	00032353	ud	V13P41	26,18



⑩



⑪



⑫



⑬



⑭



⑮



⑯

Éuronit

PLACAS

Yesos

Descripción	Fabricante	Código	U.V.	F. P.	PVP €
YESO RAPIDO IBERPLAST 17 kg	PLACO		ud	V13P74	CONSULTAR
YESO FINO ACABADO IBERFINO 17 kg	PLACO		ud	V13P74	CONSULTAR
YESO CONTROLADO LONGIPS 17 kg	PLACO		ud	V13P74	CONSULTAR
YESO MANUAL DURO THD	PLACO		ud	V13P74	CONSULTAR
YESO MANUAL PERLINOR PLUS 20 kg	PLACO		ud	V13P74	CONSULTAR
YESO MANUAL PERLINOR SUPER 20 kg	PLACO		ud	V13P74	CONSULTAR



YESO PROYECTAR PROYAL XXI 20 kg	PLACO		ud	V13P74	CONSULTAR
YESO PROYECCION PROYAL 20 kg	PLACO		ud	V13P74	CONSULTAR
YESO PROYECCION PROYAL MAX 20 kg	PLACO		ud	V13P74	CONSULTAR
YESO PROYECCION PERLINOR 20 kg	PLACO		ud	V13P74	CONSULTAR
YESO PROYECCION PROLITE	PLACO		ud	V13P74	CONSULTAR



YESO MECAFINO BANDA AZUL 17 kg	PLACO		ud	V13P74	CONSULTAR
YESO MECAFINO BANDA ORO GA 17 kg	PLACO		ud	V13P74	CONSULTAR
YESO MECAFINO MAX 17 kg	PLACO		ud	V13P74	CONSULTAR
YESO MECAFINO PLUS GA 17 kg	PLACO		ud	V13P74	CONSULTAR



ESCAYOLA IBERYOLA GA 17 kg	PLACO		ud	V13P29	CONSULTAR
-----------------------------------	-------	--	----	--------	-----------



PEGAMENTO ESCAYOLA IBERCOL 17 kg	PLACO		ud	V13P29	CONSULTAR
PEGAMENTO ESCAYOLA TABICOL 17 kg	PLACO		ud	V13P29	CONSULTAR
IMPRIMACION IBERPRIMER 12 kg	PLACO		ud	V13P74	CONSULTAR
IMPRIMACION IBERCONTAK 15 kg	PLACO		ud	V13P74	CONSULTAR



Techos

PLACA PARA TECHO CONTINUO FONOABSORBENTE

Descripción	Fabricante	Código	U.V.	F. P.	PVP €
① GYPTONE LINE TIPO 5 4BA 2700x900	PLACO	99261999	m ²	V13P67	29,75
② GYPTONE LINE TIPO 6 4BA 1200x2400	PLACO	00009092	m ²	V13P67	27,47
③ GYPTONE QUATTRO 41 4BA 1200x2400	PLACO	00009056	m ²	V13P67	27,74
④ GYPTONE QUATTRO 42 4BA 2400x1200	PLACO	00009063	m ²	V13P67	27,74
⑤ GYPTONE QUATTRO 43 4BA 2700x900	PLACO	99135942	m ²	V13P67	29,75
⑥ GYPTONE QUATTRO 46 4BA 2400x1200	PLACO	99305943	m ²	V13P67	27,74
⑦ GYPTONE QUATTRO 47 4BA 2400x1200	PLACO	00009087	m ²	V13P67	27,74
⑧ GYPTONE SIXTO 63 4BA 2400x1200	PLACO	02458324	m ²	V13P67	27,74
⑨ GYPTONE SIXTO 65 4BA 2700x900	PLACO	71879628	m ²	V13P67	29,75
⑩ RIGITONE 6/18 1188x1998	PLACO	04273732	m ²	V13P67	30,15
⑪ RIGITONE 8/18 1188x1998	PLACO	00015440	m ²	V13P67	26,89
⑫ RIGITONE 8/18Q 1188x1998	PLACO	00015457	m ²	V13P67	26,89
⑬ RIGITONE 8-15/20 1200x2000	PLACO	00015426	m ²	V13P67	26,89
⑭ RIGITONE 8-15/20 SUPER 1200x1960	PLACO	00015439	m ²	V13P67	26,89
⑮ RIGITONE 12-20/66 1188x1980	PLACO	00015374	m ²	V13P67	26,89
⑯ RIGITONE 12/25Q 1200x2000	PLACO	99143660	m ²	V13P67	26,89
⑰ RIGITONE 12/25 1200x2000	PLACO	99143653	m ²	V13P67	31,05
⑱ RIGITONE 15/30 1200x2010	PLACO	99239392	m ²	V13P67	31,05
⑲ RIGITONE 10/23 1196x2000	PLACO	99315157	m ²	V13P67	31,05

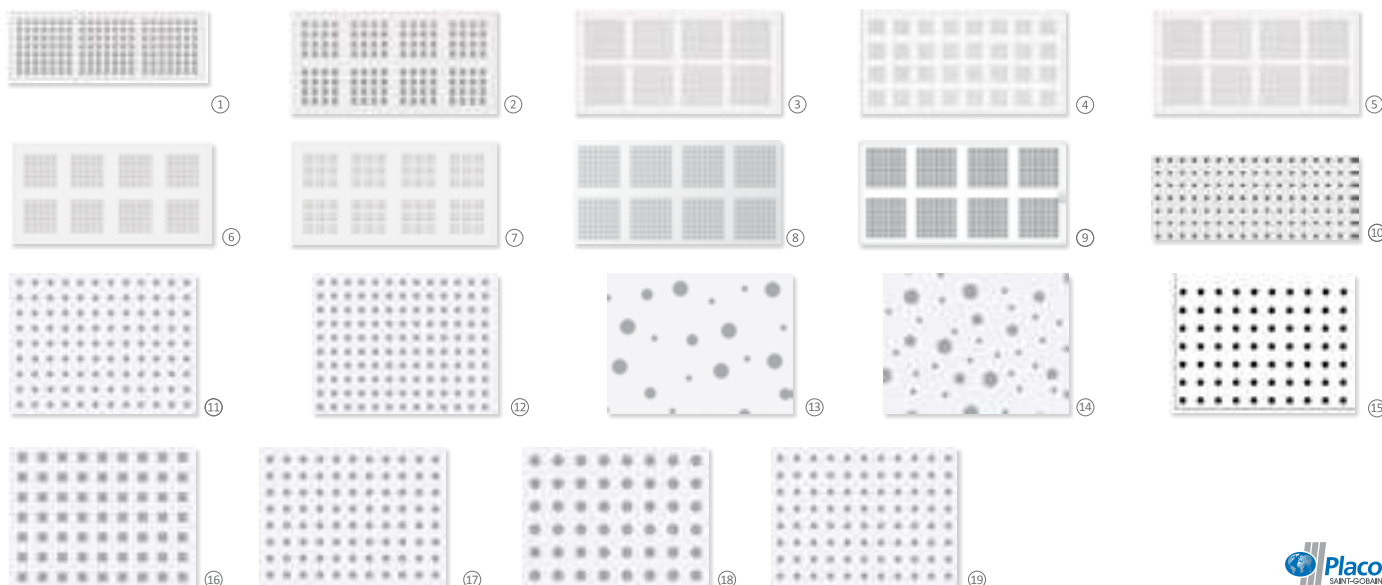

SET JUNTAS RIGITONE	PLACO	00031224	cj	V13P02	147,58
BOQUILLA PISTOLA JUNTAS RIGITON	PLACO	00031237	cj	V13P02	10,79
TORNILLO RIGI 3,5x30 mm 500UD/CJ	PLACO	99144210	cj	V13P95	14,78
SELLADOR NEUTRO RIKOMBI	PLACO	00034906	ud	V13P02	20,24



GUIA MONTAJE RIGITONE 6/18 2UD/CJ	PLACO	00008934	cj	V13P44	21,70
GUIA MONTAJE RIGITONE 8/18 2UD/CJ	PLACO	00008916	cj	V13P44	21,70
GUIA MONTAJE RIGITONE 8/18 Q 2UD/CJ	PLACO	00008921	cj	V13P44	21,70
GUIA MONTAJE RIGITONE 10/23 2UD/CJ	PLACO	00008893	cj	V13P44	21,70
GUIA MONTAJE RIGITONE 12/25 2UD/CJ	PLACO	99232467	cj	V13P44	21,70
GUIA MONTAJE RIGITONE 12/25 Q 2UD/CJ	PLACO	99135823	cj	V13P44	21,70
GUIA MONTAJE RIGITONE 15/30 2UD/CJ	PLACO	00008907	cj	V13P44	21,70
GUIA MONTAJE RIGITONE 12-20/60 2UD/CJ	PLACO	99143699	cj	V13P44	21,70
GUIA MONTAJE RIGITONE 8-15/20 2UD/CJ	PLACO	99259187	cj	V13P44	21,70
GUIA MONTAJE RIGITONE 12-20/35 2UD/CJ	PLACO	99285922	cj	V13P44	21,70

¡Novedad! Nueva gama

ULTIPRO

PASTAS EN POLVO

Descripción	Fabricante	Código	U.V.	F. P.	PVP €
① PASTA JUNTAS LENTA ULTIPRO SACO 25 kg	ULTIPRO	05002212	sac	V13P94	31,75
② PASTA JUNTAS RAPIDA 1/2 H ULTIPRO BOLSA 5 kg	ULTIPRO	05002227	sac	V13P94	7,62
③ PASTA AGARRE ULTIPRO SACO 25 kg	ULTIPRO	05002230	sac	V13P94	16,29
④ PASTA JUNTAS RAPIDA 2 H ULTIPRO SACO 25 kg	ULTIPRO	71388731	sac	V13P94	31,11



①



②



③



④

ULTIPRO

PASTAS PREPARADAS

Descripción	Fabricante	Código	U.V.	F. P.	PVP €
③ PASTA JUNTAS PREPARADA ULTIPRO BOTE 25 kg	ULTIPRO	05002241	ud	V13P94	30,30
④ PASTA JUNTAS PREPARADA ULTIPRO BOTE 7 kg	ULTIPRO	05002258	ud	V13P94	12,28



③



④

ULTIPRO

CINTAS

Descripción	Fabricante	Código	U.V.	F. P.	PVP €
⑦ CINTA JUNTAS 150 m ULTIPRO	ULTIPRO	05002199	rl	V13P02	9,08
⑧ CINTA GUARDAVIVOS 30 m ULTIPRO	ULTIPRO	05002203	rl	V13P02	24,34
⑨ BANDA ESTANCA 45 mm x 30 ml ULTIPRO	ULTIPRO	71406323	rl	V13P02	11,96
⑩ BANDA ESTANCA 65 mm x 30 ml ULTIPRO	ULTIPRO	71406309	rl	V13P02	16,28



⑦



⑧



⑨



⑩

ULTIPRO

Solución profesional



TORNILLOS TTPC

Descripción	Fabricante	Código	U.V.	F. P.	PVP €
⑪ TORNILLOS ULTIPTRO TIPO TTPC 3,5x25 mm CAJA 1000	ULTIPRO	05002265	cj	V13P02	8,75
⑫ TORNILLOS ULTIPTRO TIPO TTPC 3,5x35 mm CAJA 1000	ULTIPRO	05002276	cj	V13P02	11,83
⑬ TORNILLOS ULTIPTRO TIPO TTPC 3,5x45 mm CAJA 1000	ULTIPRO	05002294	cj	V13P02	15,00



TORNILLOS TRPF

Descripción	Fabricante	Código	U.V.	F. P.	PVP €
⑭ TORNILLOS ULTIPTRO TIPO TRPF 3,5x9,5 mm CAJA 200	ULTIPRO	05002289	cj	V13P02	3,55
⑮ TORNILLOS ULTIPTRO TIPO TRPF 3,5x13 mm CAJA 500	ULTIPRO	71388742	cj	V13P02	10,33



TRAMPILLAS

Descripción	Fabricante	Código	U.V.	F. P.	PVP €
⑯ TRAMPILLA PLACA ALUMINO PPM 12,5x200x200	ULTIPRO	04994183	ud	V13P20	42,30
⑰ TRAMPILLA PLACA ALUMINO PPM 12,5x300x300	ULTIPRO	04994198	ud	V13P20	47,90
⑱ TRAMPILLA PLACA-ALUMINO PPM 12,5x400x400	ULTIPRO	71406215	ud	V13P20	54,65
⑲ TRAMPILLA PLACA ALUMINO PPM 12,5x500x500	ULTIPRO	04994226	ud	V13P20	54,65
⑳ TRAMPILLA PLACA-ALUMINO PPM 12,5x600x600	ULTIPRO	71406244	ud	V13P20	71,45
㉑ TRAMPILLA PLACA-ALUMINO PPM 12,5x1200x600	ULTIPRO	71388713	ud	V13P20	99,28
㉒ TRAMPILLA METALICA LACADA 200x200	ULTIPRO	05035575	ud	V13P20	37,60
㉓ TRAMPILLA METALICA LACADA 300x300	ULTIPRO	04994169	ud	V13P20	46,60
㉔ TRAMPILLA METALICA LACADA 400x400	ULTIPRO	71406282	ud	V13P20	55,45
㉕ TRAMPILLA METALICA LACADA 500x500	ULTIPRO	04994170	ud	V13P20	65,80
㉖ TRAMPILLA METALICA LACADA 600x600	ULTIPRO	71406297	ud	V13P20	77,40



⑯ ⑰ ⑱ ⑲ ⑳ ㉑

㉒ ㉓ ㉔ ㉕ ㉖

